



SUPPLIER NUMBER



OVER 20 YEARS
INDUSTRY EXPERIENCE
OPTIMISED LIGHTING
AND SAFETY SOLUTIONS



Automotive / Off-road

LED Lights



Light Bars



Vehicle
Specific Kits



Automotive
Accessories



Heavy Equipment / Marine

Heavy &
Medium Duty
Lighting

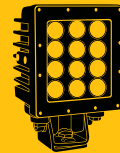

Heavy
Equipment/
Machine
Accessories



Maritime





AUTOMOTIVE / OFF-ROAD

CONTENTS

LED LIGHTS

Cannon Series	10
Transporter Series	12
Optimus Series	14
Solo Pod Series	16

LIGHT BARS

PX [Prime Xtreme].	22
XPR-S	23
XPR	24
LPX [Lo-Pro Prime Xtreme]	25
Xmitter	26
Chaser Rear LED System	27

VEHICLE SPECIFIC KITS

Jeep JK	30
Ford Raptor/F-Series	31
Dodge, Toyota, GMC, Chevrolet	32
Polaris RZR, Yamaha YXZ	33

AUTOMOTIVE ACCESSORIES

Auto Accessories and Kits	34
Polycarbonate Light Covers	46
Accent Lighting	48
Subaqua	50
Mounting Solutions	51



HEAVY EQUIPMENT / MARINE

CONTENTS

HEAVY / MEDIUM DUTY LIGHTING

55	Ripper Series
57	Solstice Prime Series
59	Shockwave Series
61	Utility Market Xtreme
63	Duralux Series

HEAVY EQUIPMENT/MACHINE ACCESSORIES

65	Construction Area Light
66	Utility Flood
67	Strobe Beacons
68	2 & 3 Digit LED Vehicle ID Board
68	Mini Incident Response Kit

MARITIME

70	Marine Ripper
71	Maritime Explorer
71	Marine 4.5" Light Cannon

VISION X LIGHTING

DESIGN, MANUFACTURE AND DELIVER
THE ULTIMATE LIGHTING SOLUTION



VISION X HISTORY

Since 1997, Vision X has been providing the lighting solutions demanded by the market as well as innovating the next step for lighting. With the release of the HID series in late 2005, Vision X was the first to provide an HID internal ballast and starter to the mass market, simplifying installation and reducing external components. Again in 2008, Vision X revolutionized lighting with the LED bar originally produced for NASA's Back to the Moon Mission. Since then, Vision X has continued innovation with the Solo Pod - which gives as many lumens as a headlight from a single 2" x 2" housing - and heavy duty LED lighting for use in mining, industrial, and commercial applications. At Vision X, we are constantly striving to live up to our company motto of "Lighting Evolved."



QUALITY AS A PRIORITY

PRODUCT TESTING

CONSUMPTION/INPUT RANGE



All products are put on a digital power meter to test that it is consuming the correct amount of power, checking for any electrical faults.

LONG TERM DURABILITY



Products are then switched on and off 20,000 times repeatedly to ensure that they remain functional after all testing.

SUBMERSION/AGING



Once products are assembled every product is run through a submersion (water dunk test), then placed onto an aging rack and powered up for 30 minutes.

THERMAL IMPACT



Products are placed in a -40°C chamber for 30 minutes, and then placed in a 80°C chamber for an additional 30 minutes. Products are then left on for 72 hours.

PHOTOMETRIC



Lights are tested in the Goniophotometer to model the beam pattern and depict the overall light output.

TEMPERATURE AND HUMIDITY



Products are placed in a 60°C, 94% humidity chamber and left operational for 72 hours. Afterwards, products are inspected for moisture and damage.

INGRESS



Products are sprayed from close distances with 80~100 BAR water pressure to verify the Ingress Protection rating, ensuring they are sealed properly.

VIBRATION



Products are placed on the vibration shock for 4 hours to test that they can withstand the rated vibration standard. Products tested at 60 Grms are performed off-site.

HIGH LEVEL CERTIFICATIONS

PHOTO BIOLOGICAL

IEC
62471

Ensures that light output has safe levels of UV exposure for both skin and eyes.

ROHS

RoHS

Ensures no use of restricted hazardous materials in products such as lead, mercury, cadmium, PBB, PBDE, and Phthalate.

DOT



US Department of Transportation certified for on road use.

UL



UL Certification is recognized around the world as a way to ensure standards.

ATEX 94 (94/9/EC)



The ATEX 94 certification is given to electronic equipment that is resistant to flame and explosion.

E-MARK



European Regulatory certification for on highway use.

ADR 13/00



Products which are in compliance with the Australian Design Rules (ADR).

IP RATING

IP-69K

Ingress Protection rates protection against outside elements. First number is solids, second is liquids.

CE



CE is a mandatory conformity mark for products in the European Economic Area.

EMC



EMC and EMI certifies that a product does not interfere with other electrical products. This includes CISPR 25 Certifications

VISION X LIGHTING

ENGINEERED SOLUTION PROCESS

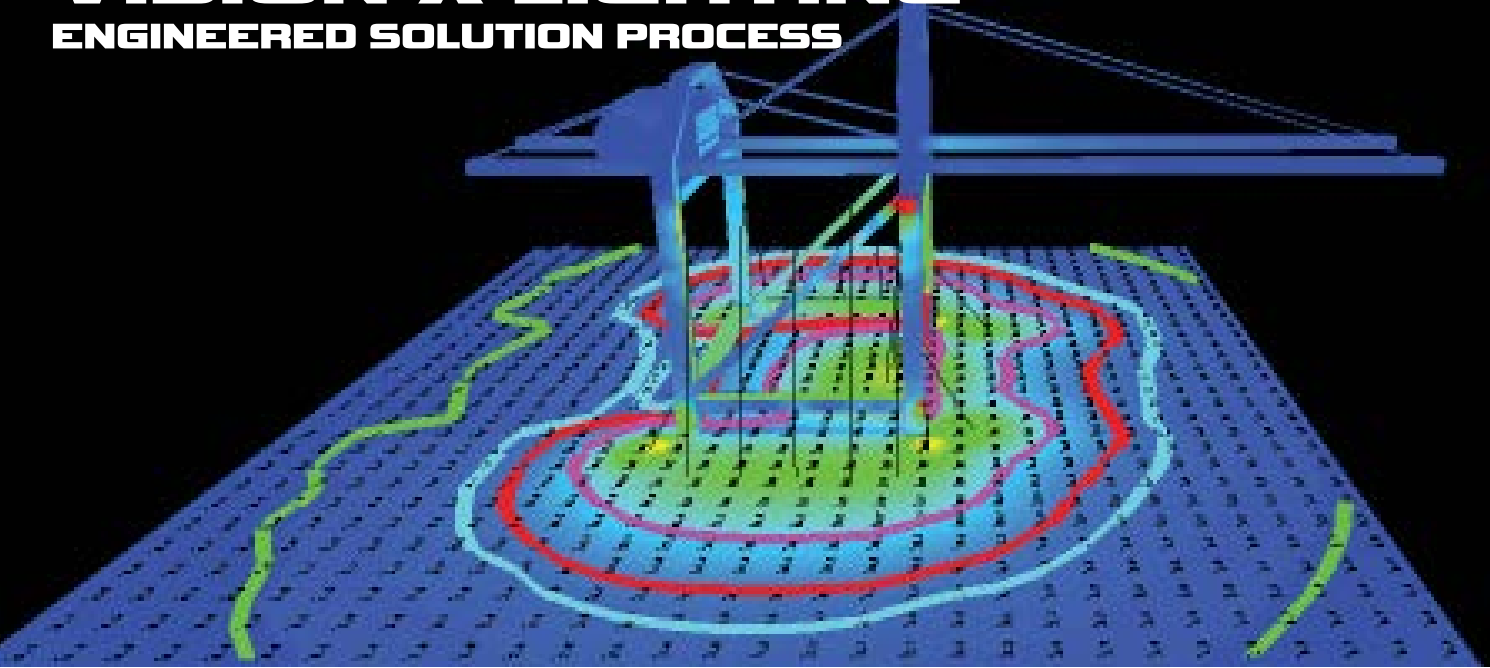

2D BLUEPRINT

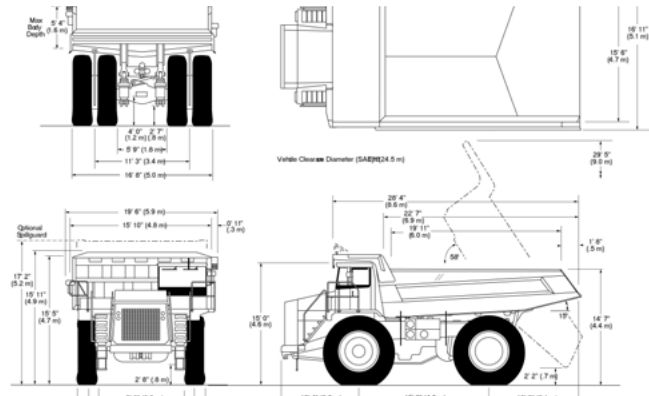

Vision X begins a project by requesting the list of machines that will be needed to be retrofitted. Then gathering the technical information for those machines.

3D MODEL



A 3D Model is then built to match the customer's exact specifications. This model is then carried over into the rendering.

SIMULATION RENDER

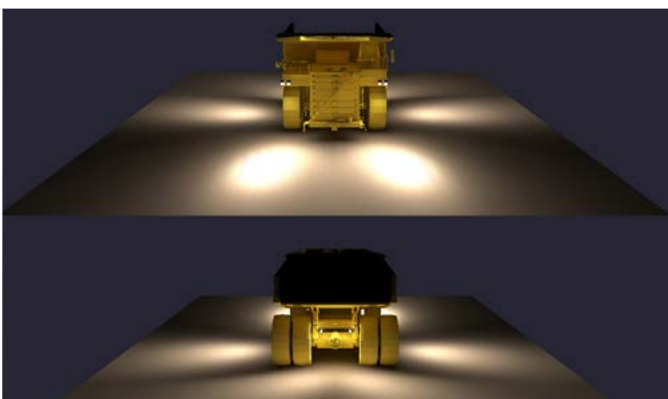

Prior to implementing a lighting solution, Vision X creates a simulation rendering of the intended result to help envision if the final product will meet lighting requirements.

SOLUTION

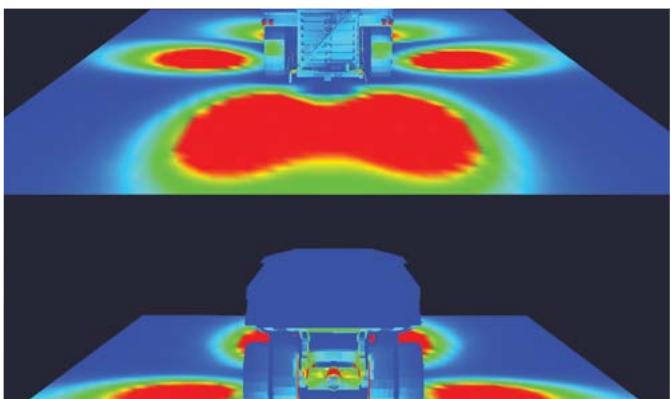

Vision X creates a complete breakdown of what the customer needs to meet their specific requirements for safety.

CONTINUOUS IMPROVEMENT

ISO
Vision X Meets ISO 9001,
ISO 14001 Standards

20
Years of Experience
with Finding Lighting
Solutions

ECOPROFIT
Award Winning Factory
for Environmental
Responsibility

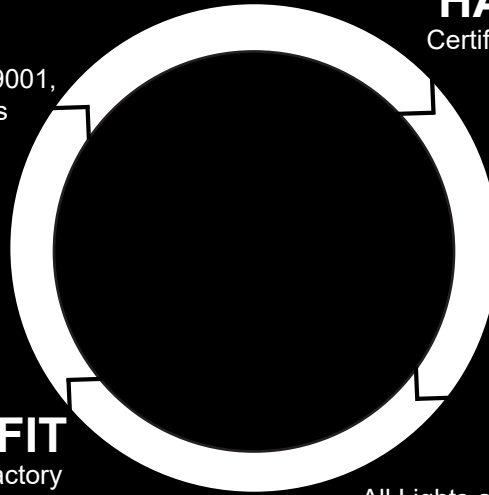

HAZCOM
Certified HAZCOM
Program

140
Vision X Lighting is
Currently Active in 140
Countries Worldwide

**Photo
Biological**
All Lights are Photo Biologically
Tested Safe for Human Skin and Eyes

ENGINEERED PRODUCT DEVELOPMENT

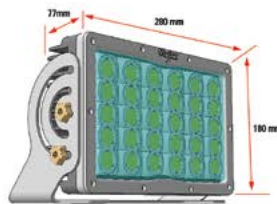
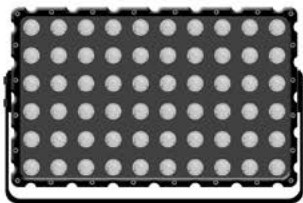

CONCEPT

RENDERING

PROTOTYPE

PRODUCTION

Vision X works with our customers around the world, our sponsorship partners and the world's leading LED manufacturers continuously to imagine new products for use in many applications. We strive to be the solution provider for any lighting need by continuously improving existing product and imagining new product.

PATENTED PRODUCT PROTECTION



Vision X ensures the protection of our products by acquiring patents and trademarks worldwide. This gives us the ability to fight "knock-off" products worldwide so that our customers can be assured they are buying Vision X Genuine products.

VISION X LIGHTING

TECHNOLOGY EXPLAINED

LED

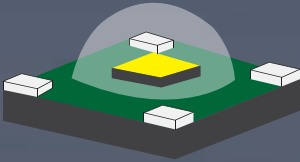

Vision X LED Lighting runs at a 6000K temperature for intense, bright white light for maximum visibility and safety. LED Lights do not use a bulb, making them much more durable than other options.

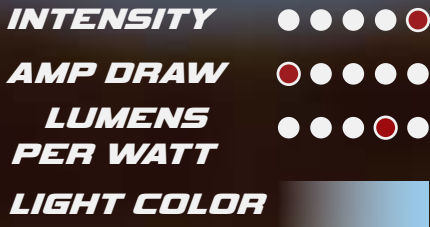

HID



Vision X HID Lighting runs at a 5000k temperature for a super white beam color. HID lights require a bulb, starter and ballast to operate. They have a higher output per wattage than Halogen bulbs.



HALOGEN



Vision X offers a number of different Halogen Lighting options. The Tungsten-Halogen series uses an oversized globe and specially engineered filament to enhance light output. Vision X offers many headlight replacements.



WHAT MAKES VISION X LED DIFFERENT

- TOP BINNING**
Not all LEDs are created equal. Each run of LEDs by the manufacturer is binned to classify the quality within that batch. Vision X uses only top-binned LEDs to ensure the highest quality.
- WEATHERPROOF DEUTSCH CONNECTORS**
Each Vision X product features a weatherproof deutsch connector, ensuring the functionality of the light in harsh conditions. Vision X tests each batch of lights to make sure its resistant to weather.
- HIGH EFFICACY**
Vision X products are engineered for the highest possible luminus efficacy - the ratio of lumens per watt.

- PULSE WIDTH MODULATION**
When enabled, Pulse Width Modulation integrated circuitry flashes the LED faster than the human eye can see for reduced heat, prolonged LED life and dimming capabilities.
- ELECTRONIC THERMAL MANAGEMENT**
Integrated Electronic Thermal Management automatically regulates heat levels by engaging ETM to prolong each LEDs lifespan to 50,000 hours.
- DIMMING CAPABILITY**
Prime Drive includes dimming capability. Dimming works by engaging PWM to reduce power while maintaining steady output. Vision X offers push button and dial dimmer units.

LED TYPES

- 90 WATT LED**
The Light Cannon 8.7" housing features a 90 Watt LED. Combined with IRIS Reflector Technology, this allows for 3,280 feet of usable light.
- 10 WATT LED**
The benefits of the 10 watt LED are great intensity and bulk lighting. The 10 watt LED provides the greatest bulk lighting on the market.
- 3 WATT LED**
The benefits of the 3 watt LED are great output and beam precision. The tight footprint allows for precision optical control.

- 50 WATT LED**
The Light Cannon 6.7" housing features a 50 Watt LED. Combined with IRIS Reflector Technology, this allows 2,500 feet of usable light from a single LED.
- 7 AND 6 WATT LED**
Utilizing the same footprint as the 5 watt, 7 and 6 Watt LED Lights from Vision X have an increased luminus efficacy over 5-watt LEDs. Producing up to 50% more light than 5 watt.
- SMD LED**
The Surface Mounted Diode (SMD) is used in the Shockwave fixture and UF32 to create an even, ultra-wide beam pattern for area lighting applications.

- 25 WATT**
The 4.5" Light Cannon housing features a 25 Watt LED. Combined with IRIS Reflector Technology, this allows 1,000 feet of usable light from a single LED.
- 5 WATT LED**
Utilizing the same footprint as the 3 watt LED, but at twice the output, the 5 watt LED combines the advantages of a tight LED footprint with the ultimate output.
- CUBE LED**
CUBE LEDs from Vision X are ideal for structural applications because of the 117 lumen per watt ratio. We're able to get more light output for a lower cost than standard LEDs.

USABLE LIGHT



Usable light is defined as the light that is actually converted for use in forward projection lighting. Vision X measures this by accounting for effective, rather than raw, lumens in our calculations. We also provide the measurement of distance at which a light achieves one lux. One lux is the level of light needed to read a newspaper. Vision X provides lumen ratings in effective lumens, which factors in the levels of optical, electrical and heat loss. This states the true output of the light as a whole, not just a single component such as the LED.

ISOLUX CHART

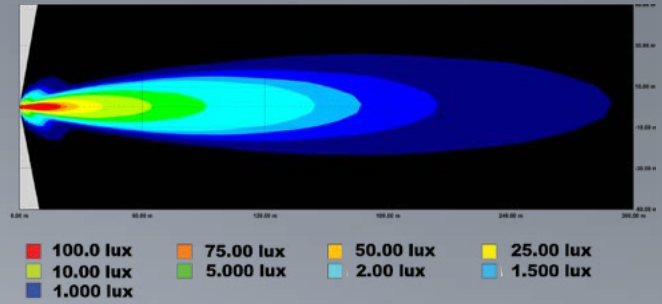

Measuring Lux

On Vision X lux charts, the different colors within a light's beam on the lux chart correlates to a different lux level at that distance from the source, according to the colors above.

TOTAL LIGHT OUTPUT = LUMENS

Overall Output from the Source

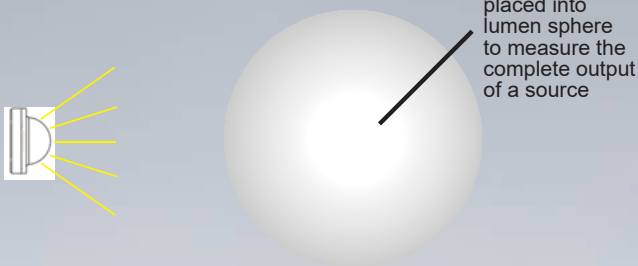

Raw Lumen Output

Lumens are a common standard for measuring light output at the source. It is important to know that the lighting source manufacturer rating is only for the light source and does not account for losses due to optical inefficiencies, electrical inefficiencies or heat.

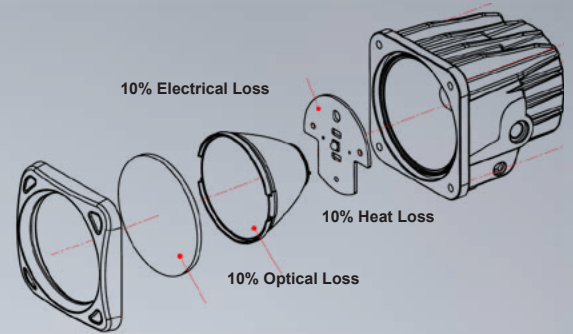

Effective Lumen Output

The sheer output of the light source is not enough to capture the whole story. When rating the effective output of a light source, the light lost as heat, in optical light spray and electrical inefficiency must also be accounted for, as each of these reduce the total usable lumens.

LIGHT AT A SPECIFIC POINT = LUX AND FOOT CANDLES

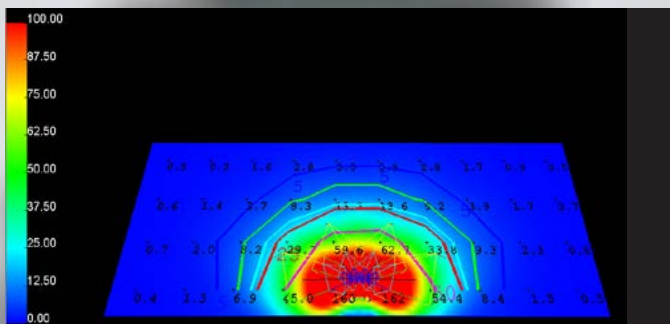

Lux

Lux measures the amount of light per square meter. Unlike lumens which measures light at the source, lux is measured at a specific area. This helps better determine whether those effective lumens are lighting up the environment with the necessary light.

Foot-Candles

Foot Candle measures the amount of light per square foot, as opposed to square meter as with lux. Foot-Candle and lux are interchangeable, with 100 lux = 10.42 foot-candles.

BEAM PATTERNS ILLUSTRATED

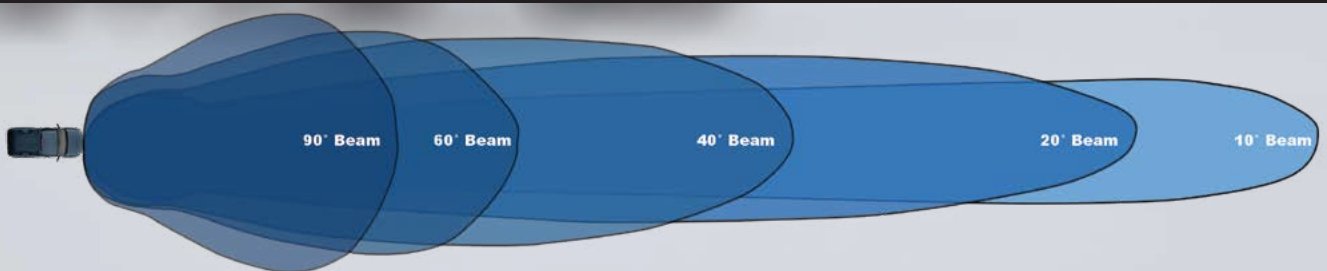

LED LIGHTS CANNON SERIES

ABOUT THE CANNON SERIES

The LED Light Cannon Series from Vision X is unmatched by any other fixture on the market. By utilizing Vision X's IRIS Reflector Technology and top binned Single-Source Luminus LEDs, the Cannon Series can produce up to 3,280 feet of usable light.

Each Light Cannon is 25 Lights In One with the help of the available polycarbonate snap-on covers that can alter the beam pattern and change the color of the Cannon. Tackle any weather condition with the proper color cover, or quickly change your spot cover to a flood cover for a wider beam when necessary.

The Light Cannon Series is sold as a single fixture, or as a complete Light Kit consisting of two lights and a dual wiring harness with lighted rocker switch.



BIG-CHIP SINGLE SOURCE LEDs

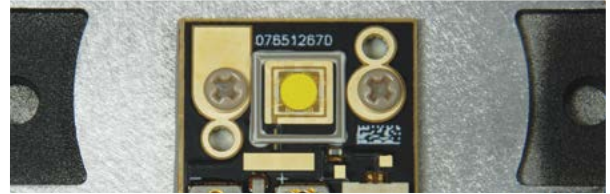

Luminus LEDs

Most LEDs on the market today are composed of smaller LEDs combined together to make one large unit. With the LED Light Cannon Series, Vision X uses larger Single Source LEDs that are one diode, capable of producing more light and a brighter source.

Light Kits Available

Each size of LED Light Cannon is available in a two light kit that includes a dual wiring harness and a lighted rocker switch.



25 LIGHTS IN ONE

- SPOT
- COMBO
- EURO
- ELLIPTICAL
- FLOOD
- WIDE FLOOD

CLEAR COVERS

Unbreakable, dust resistant protection to protect the light from debris and particulates. Recommended for users who wish to maintain original light color.



RED COVERS

Reduces light temperature and glare back in order to enhance penetration in dust and air particulates. Ideal for vehicles in extreme dust conditions.



BLUE COVERS

Increases lighting distance when used in snow conditions by reflecting the blue light off the snow. Recommended for vehicles in heavy winter conditions.



AMBER COVERS

Battles fog conditions by reducing the amount of blue light. Mimics classic Halogen color temperature. Great for driving in dust at high speeds.



BLACKOUT COVERS

Covers the fixture with a solid black protective cover with a high contrast "X" logo. Required in select states for on-road use.



4.5" 40-WATT LIGHT CANNON XP

XTREME PERFORMANCE 40-WATT SINGLE SOURCE LED PRODUCES 1,100' OF USEABLE LIGHT
10° Beam Pattern | Polycarbonate Covers Available (Round) | Two Light Kits Available



BEAM PATTERNS 10°	WEIGHT 2.02 lb / 0.92 kg	DIMENSIONS 4.72" x 5.75" x 4.35"
RAW LUMENS 3,000 lm (ea)	DISTANCE TO 1 LUX 1,115'	METRIC 120mm x 147mm x 110mm

40 WATT
L.S.S.

EX
EXTENDED WARRANTY

Multi-Volt
9-32V
DC INPUT

Hy
HYBRID HOUSING

IP-68
WATERPROOF

IRIS REFLECTOR

40° - +80°C
OPERATION TEMP

50,000 HR
LIFESPAN

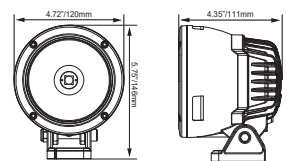

ITEM #	PART #	QTY	BEAM
CTL-CPZ110XP	9893259	1	10°
CTL-CPZ110XPKIT	9893365	2	10°

*Additional Part Numbers & Technical Information On Page 18

ITEM #: CTL-CPZ110XP Shown
PART #: 9893259
*Lights Available with Black Bezels

8.7" 90-WATT LIGHT CANNON

90-WATT SINGLE SOURCE LED PRODUCES 3,280' OF USABLE LIGHT

Lightweight Hybrid Housing | Long Range IRIS Reflectors | Snap-On Covers Change Beam Pattern



ITEM #: CTL-CPZ810 Shown
PART #: 9890852

BEAM PATTERNS 10°	WEIGHT 10.36 lb / 4.7 kg	DIMENSIONS 8.71" x 10.58" x 4.57"
RAW LUMENS 5,800 lm (ea)	DISTANCE TO 1 LUX 3,280'	METRIC 221mm x 269mm x 116mm



ITEM #	PART #	QTY	BEAM
CTL-CPZ810	9890852	1	10°
CTL-CPZ810KIT	9890074	2	10°

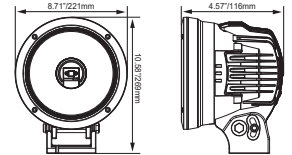

*Additional Part Numbers & Technical Information On Page 18

6.7" 50-WATT LIGHT CANNON

50-WATT SINGLE SOURCE LED PRODUCES 2,500' OF USABLE LIGHT

Lightweight Hybrid Housing | Long Range IRIS Reflectors | Snap-On Covers Change Beam Pattern



ITEM #: CTL-CPZ610 Shown
PART #: 9888538

BEAM PATTERNS 10°, 20°	WEIGHT 5.51 lb / 2.5 kg	DIMENSIONS 6.69" x 8.82" x 6.31"
RAW LUMENS 3,200 lm (ea)	DISTANCE TO 1 LUX 2,500'	METRIC 170mm x 224mm x 160mm

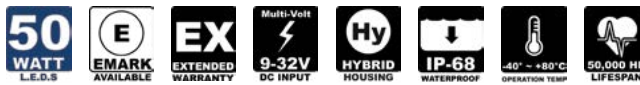

ITEM #	PART #	QTY	BEAM
CTL-CPZ610	9888538	1	10°
CTL-CPZ610KIT	9888545	2	10°
CTL-CPZ620	9891736	1	20°
CTL-CPZ620KIT	9891743	2	20°

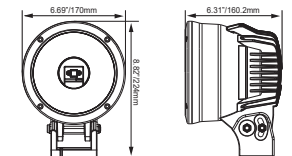

*Additional Part Numbers & Technical Information On Page 18

4.5" 25-WATT LIGHT CANNON

25-WATT SINGLE SOURCE LED PRODUCES 1,000' OF USABLE LIGHT

Lightweight Hybrid Housing | Long Range IRIS Reflectors | Snap-On Covers Change Beam Pattern



ITEM #: CTL-CPZ110 Shown
PART #: 9150970

BEAM PATTERNS 10°	WEIGHT 2.02 lb / 0.92 kg	DIMENSIONS 4.72" x 5.75" x 4.35"
RAW LUMENS 2,500 lm (ea)	DISTANCE TO 1 LUX 1,000'	METRIC 120mm x 147mm x 110mm

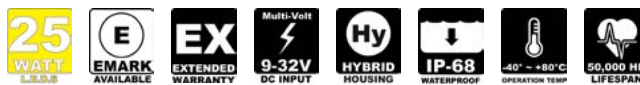

ITEM #	PART #	QTY	BEAM
CTL-CPZ110	9150970	1	10°
CTL-CPZ110KIT	9151069	2	10°

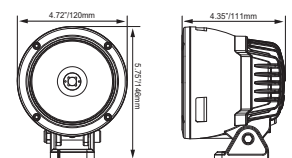

*Additional Part Numbers & Technical Information On Page 18

LED LIGHTS

TRANSPORTER SERIES

ABOUT THE TRANSPORTER SERIES

The Transporter Series utilizes high powered 5-watt LEDs to provide intense light output for commercial applications. The Transporter Series is ideal for long-haul Trucking and Transport applications because the 50,000 hour lifespan takes away from unscheduled fleet maintenance like bulb replacement, etc.

Additionally, brighter driving conditions for operators ensures greater safety and reliability for drivers on the road. Proper lighting can reduce the amount of time it takes for a load to be delivered and can also reduce the chances for an accident on roadways affected by harsh conditions.

COVERS AVAILABLE



ADVANCED MOUNTING



KNURLED AIMING KNOBS

The Transporter Series can be precisely adjusted to any angle within 15° thanks to the knurled adjustment knobs located at the base of the fixture.

LIGHTED ROCKER HARNESS



INCLUDED HARNESS

The Transporter Series comes packaged with a single light wiring harness with lighted rocker switch for activation and a weatherproof deutsch connector, ensuring the longevity of the light. Mounting and wiring is a breeze so you'll be out on the road in no time.

RECESSED OPTICS



SMOOTH BEAM PATTERN

Each Transporter produces a smooth and even beam pattern due to the recessed reflectors that are precisely angled to achieve an effective beam pattern for on-road driving.



TRANSPORTER 18 LED



ITEM #: CTL-TPX1810 Shown
PART #: 9111018

90-WATT LED LIGHT FOR LONG-HAUL TRUCK AND TRANSPORT

Eighteen 5-Watt LEDs | Protective Polycarbonate Covers Available | Truck and Transport Ready

BEAM PATTERNS 10°, 40°	WEIGHT 6.17 lb / 2.8 kg	DIMENSIONS 6.42" x 7.19" x 4.57"
RAW LUMENS 9,504 lm (ea)	DISTANCE TO 1 LUX 840'	METRIC 171mm x 183mm x 116mm



ITEM #	PART #	QTY	BEAM
CTL-TPX1810	9111018	1	10°
CTL-TPX1840	9111193	1	40°

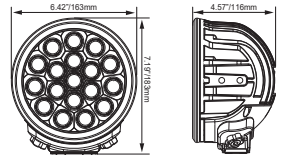

*Additional Part Numbers & Technical Information On Page 18

TRANSPORTER 12 LED



ITEM #: CTL-TPX1210 Shown
PART #: 9110561

60-WATT LED LIGHT FOR LONG-HAUL TRUCK AND TRANSPORT

Twelve 5-Watt LEDs | Protective Polycarbonate Covers Available | Truck and Transport Ready

BEAM PATTERNS 10°, 40°	WEIGHT 5.95 lb / 2.7 kg	DIMENSIONS 6.42" x 7.19" x 4.57"
RAW LUMENS 6,336 lm (ea)	DISTANCE TO 1 LUX 778'	METRIC 171mm x 183mm x 116mm



ITEM #	PART #	QTY	BEAM
CTL-TPX1210	9110561	1	10°
CTL-TPX1240	9110745	1	40°

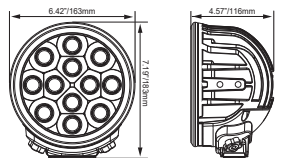

*Additional Part Numbers & Technical Information On Page 18

TRANSPORTER 9 LED



ITEM #: CTL-TPX910 Shown
PART #: 9110110

LED LIGHT FOR LONG-HAUL TRUCK AND TRANSPORT

Nine 5-Watt LEDs | Protective Polycarbonate Covers Available | E-Mark Approved Fixture

BEAM PATTERNS 10°, 40°	WEIGHT 5.95 lb / 2.7 kg	DIMENSIONS 6.42" x 7.19" x 4.57"
RAW LUMENS 4,752 lm (ea)	DISTANCE TO 1 LUX 656'	METRIC 163mm x 183mm x 116mm

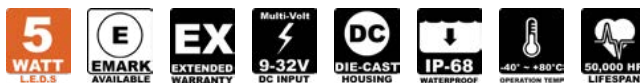

ITEM #	PART #	QTY	BEAM
CTL-TPX910	9110110	1	10°
CTL-TPX940	9110295	1	40°

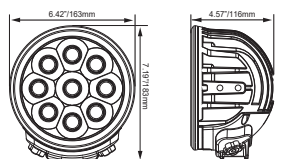

*Additional Part Numbers & Technical Information On Page 18

LED LIGHTS OPTIMUS SERIES

ABOUT THE OPTIMUS SERIES

By combining Single-Source LEDs with Vision X's IRIS Reflector Technology, the Optimus Series is capable of reaching powerful distances from a small housing. The Optimus is available in three different beam patterns, allowing users to choose between distance or spread.

Kits consisting of two lights and a wiring harness are available for each member of the Optimus family, and each is also available in Black, Chrome or White housing colors.

The Optimus Series is often used in Vision X Vehicle Specific Kits, to see the available options and to learn more please see page 60.

COVERS AVAILABLE

TWO LIGHT KIT



- Black
- White
- Chrome

COMPLETE KIT

Each model in the Optimus Series can be purchased in a complete lighting kit consisting of two fixtures, a dual-wiring harness, and necessary mounting. Everything you need to explore the night.



OPTIMUS HALO

LONG-RANGE 10-WATT LED WITH BRIGHT LED HALO RING
15° Beam Pattern | Polycarbonate Covers Available (Round) | Two Light Kits Available



Round
ITEM #: XIL-OPRH115 Shown
PART #: 9891712

Square
ITEM #: XIL-OPH115 Shown
PART #: 9891699

BEAM PATTERNS 15°	WEIGHT 1.37 lb / 0.62 kg	ROUND DIMENSIONS 3.62 x 3.62 x 3.79"/92 x 92 x 96mm
RAW LUMENS 1,052 lm (ea)	DISTANCE TO 1 LUX 680'	SQUARE DIMENSIONS 2.99 x 2.99 x 3.79"/76 x 76 x 97mm

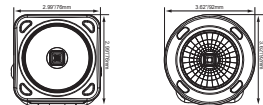

ITEM #	PART #	QTY	HOUSING	ITEM #	PART #	QTY	HOUSING
XIL-OPRH115	9891712	1	Round	XIL-OPRH115KIT	9891729	2	Round
XIL-OPH115	9891699	1	Square	XIL-OPH115KIT	9891705	2	Square

*Additional Part Numbers & Technical Information On Page 19

OPTIMUS SINGLE

10-WATT UNIVERSAL LED DRIVING LIGHT PRODUCES ULTIMATE DISTANCE

Compact 3.0" Housing | High-Strength Adjustable Trunnion Mount | Two Light Kits Available



ITEM #: XIL-OP110 Shown
PART #: 9123882

BEAM PATTERNS 10°, 20°, 60°	WEIGHT 1.37 lb / 0.62 kg	DIMENSIONS 2.99" x 2.99" x 3.82"
RAW LUMENS 1,052 lm (ea)	DISTANCE TO 1 LUX 883'	METRIC 76mm x 80.5mm x 97mm



ITEM #	PART #	QTY	BEAM	ITEM #	PART #	QTY	BEAM
XIL-OP110	9123882	1	10°	XIL-OP110KIT	9124421	2	10°
XIL-OP120	9130002	1	20°	XIL-OP120KIT	9138015	2	20°
XIL-OP160	9124063	1	60°	XIL-OP160KIT	9137926	2	60°

*Additional Part Numbers & Technical Information On Page 19

OPTIMUS ROUND

10-WATT UNIVERSAL LED DRIVING LIGHT PRODUCES ULTIMATE DISTANCE

Compact 3.0" Housing | Snap-On Color & Beam Changing Covers | Two Light Kits Available



ITEM #: XIL-OPR110 Shown
PART #: 9140896

BEAM PATTERNS 10°, 20°, 60°	WEIGHT 1.53 lb / 0.69 kg	DIMENSIONS 3.62" x 3.62" x 3.82"
RAW LUMENS 1,052 lm (ea)	DISTANCE TO 1 LUX 883'	METRIC 92mm x 92mm x 97mm



ITEM #	PART #	QTY	BEAM	ITEM #	PART #	QTY	BEAM
XIL-OPR110	9140896	1	10°	XIL-OPR110KIT	9141251	2	10°
XIL-OPR120	9141077	1	20°	XIL-OPR120KIT	9141343	2	20°
XIL-OPR160	9141169	1	60°	XIL-OPR160KIT	9141435	2	60°

*Additional Part Numbers & Technical Information On Page 19



VIEW COVERS
Page 47

OPTIMUS DUAL

20-WATT UNIVERSAL LED DRIVING LIGHT PRODUCES ULTIMATE DISTANCE

Power Of Two Optimus In One | Available In Kits | High-Strength Adjustable Trunnion Mount



ITEM #: XIL-OP210 Shown
PART #: 9123882

BEAM PATTERNS 10°, 20°, 60°	WEIGHT 2.25 lb / 1.02 kg	DIMENSIONS 5.83" x 3.82" x 4.80"
RAW LUMENS 2,104 lm (ea)	DISTANCE TO 1 LUX 1,240'	METRIC 148mm x 97mm x 122mm



ITEM #	PART #	QTY	BEAM	ITEM #	PART #	QTY	BEAM
XIL-OP210	9123882	1	10°	XIL-OP210KIT	9125053	2	10°
XIL-OP220	9124605	1	20°	XIL-OP220KIT	9137834	2	20°
XIL-OP260	9136660	1	60°	XIL-OP260KIT	9137742	2	60°

*Additional Part Numbers & Technical Information On Page 19

LED LIGHTS SOLO POD SERIES

ABOUT THE SOLO SERIES

Compact yet powerful, the Solo Pod Series from Vision X provides intense light output from a small housing. Each Solo produces the equal light output of a pair of headlights from a modern vehicle.

The Solstice Solo excels at multiple applications thanks to the wide selection of different beam patterns. Perfect for dirt bikes, reverse lights, marine lights, or rock lights - the applications are endless.

Additionally, there are multiple accessories that can further extend the versatility of the Solstice Solo.

FLEXIBLE MOUNTING



SINGLE-BOLT MOUNTING SYSTEM

The Solstice Solo uses a single-bolt mounting system with an adjustable aiming system allowing for precision aiming in hard to reach spots.

OMNI-LINK CONNECTORS



ENDLESS CONFIGURATIONS

With the Omni-Link Connector, simply connect Solstice Solo Pods together to create unique lengths and configurations, as well as add numerous accessories for various applications.

ACCESSORIES

FLUSH MOUNT
3" Flush Mount Adapter



HANDLE
Pistol Grip Handle



HANDLE BAR CLAMP
0.75"- 1.25" Mounting



SOLO PRIME POD



ITEM #: XIL-SP110 Shown
PART #: 4008830

ULTIMATE 10-WATT LED POD FOR UNIVERSAL APPLICATIONS

Omni-Link Interlocking System | Electronic Thermal Management | Flush Mount Bracket Available

BEAM PATTERNS 10°, 20°, 40°	WEIGHT 0.70 lb / 0.32 kg	DIMENSIONS 2.17" x 3.35" x 2.36"
RAW LUMENS 1,052 lm (ea)	DISTANCE TO 1 LUX 279'	METRIC 55mm x 85mm x 60mm

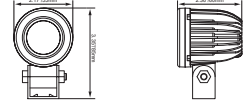

ITEM #	PART #	BEAM
XIL-SP110	4008830	10°
XIL-SP120	4009882	20°
XIL-SP140	4009899	40°

*Additional Part Numbers & Technical Information On Page 20

SOLSTICE SOLO



ITEM #: XIL-S1110 Shown
PART #: 9888156

COMPACT 10-WATT LED FOR UNIVERSAL APPLICATIONS

Omni-Link Interlocking System | Small 2" Die-Cast Housing | Flush Mount Bracket Available

BEAM PATTERNS 10°, 30°, 60°, 30°x65°	WEIGHT 0.76 lb / 0.34 kg	DIMENSIONS 2.05" x 3.24" x 2.44"
RAW LUMENS 1,052 lm (ea)	DISTANCE TO 1 LUX 255'	METRIC 52mm x 82mm x 62mm

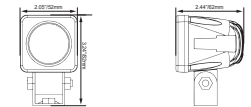

ITEM #	PART #	BEAM
XIL-S1110	9888156	10°
XIL-S1130	9888163	30°
XIL-S1160	9888170	60°

*Additional Part Numbers & Technical Information On Page 20

MINI SOLO POD



ITEM #: XIL-MX110 Shown
PART #: 9113531

COMPACT 5-WATT LED PERFECT FOR TIGHT SPOTS

Omni-Link Interlocking System | Ultra Compact Housing | Mounting Accessories

BEAM PATTERNS 10°, 25°, 40°, 60°, 90°, 30°x65°	WEIGHT 0.40 lb / 0.18 kg	DIMENSIONS 1.69" x 2.58" x 2.38"
RAW LUMENS 528 lm (ea)	DISTANCE TO 1 LUX 195'	METRIC 43mm x 65mm x 61mm

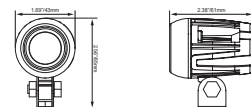

ITEM #	PART #	BEAM
XIL-MX110	9113531	10°
XIL-MX140	9113715	40°
XIL-MX160	9113807	60°

*Additional Part Numbers & Technical Information On Page 20

LED LIGHT CANNON

ITEM #	PART #	QTY	BEAM	WEIGHT	RAW LUMENS	EFFECTIVE LUMENS	INPUT VOLTS	WATTS	AMP DRAW
CTL-CPZ110	9150970	1	10°	2.02 lb	2,500 lm	1,750 lm	9-32V	25	2.08A
CTL-CPZ110KIT	9151069	2		4.04 lb	5,000 lm	3,500 lm			4.17A
CTL-CPZ110XP	9893259	1	10°	2.02 lb	3,000 lm	2,100 lm	9-32V	40	3.33A
CTL-CPZ110XPKIT	9893365	2		4.04 lb	6,000 lm	4,200 lm			6.66A
CTL-CPZ610	9888538	1	10°	5.51 lb	3,200 lm	2,240 lm	9-32V	50	4.17A
CTL-CPZ610KIT	9888545	2		11.02 lb	6,400 lm	4,480 lm			8.34A
CTL-CPZ620	9891736	1	20°	5.51 lb	3,200 lm	2,240 lm	9-32V	50	4.17A
CTL-CPZ620KIT	9891743	2		11.02 lb	6,400 lm	4,480 lm			8.34A
CTL-CPZ810	9890852	1	10°	10.36 lb	5,800 lm	4,060 lm	9-32V	90	7.5A
CTL-CPZ810KIT	9890074	2		20.72 lb	11,600 lm	8,120 lm			15A

CTL-CPZ110 | 9150970 - 10° BEAM

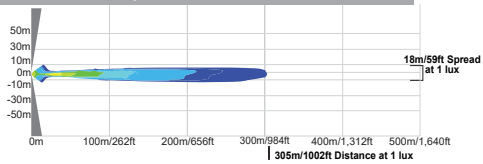

CTL-CPZ110XP | 9893259 - 10° BEAM

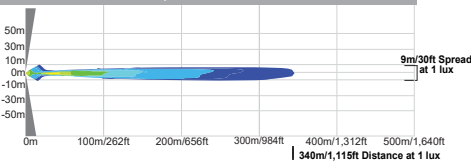

CTL-CPZ610 | 9888538 - 10° BEAM

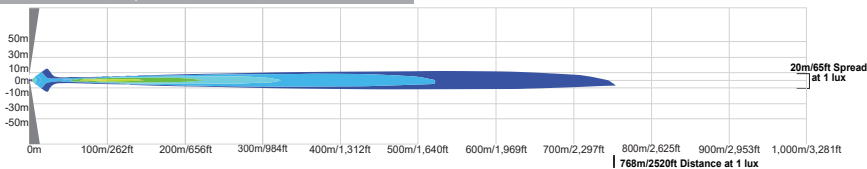

CTL-CPZ810 | 9890852 - 10° BEAM

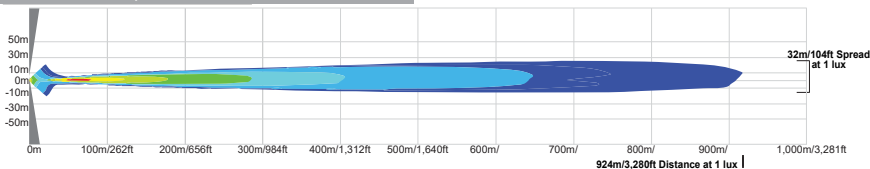

TRANSPORTER

ITEM #	PART #	# OF LEDS	BEAM	WEIGHT	RAW LUMENS	EFFECTIVE LUMENS	INPUT VOLTS	WATTS	AMP DRAW
CTL-TPX910	9110110	9	10°	5.95 lb	4,752 lm	3,330 lm	9-32V	45	3.75A
CTL-TPX940	9110295	9	40°	5.95 lb	4,752 lm	3,330 lm	9-32V	45	3.75A
CTL-TPX1210	9110561	12	10°	6.17 lb	6,336 lm	4,440 lm	9-32V	60	5A
CTL-TPX1240	9110745	12	40°	6.17 lb	6,336 lm	4,440 lm	9-32V	60	5A
CTL-TPX1810	9111018	18	10°	6.61 lb	9,504 lm	6,660 lm	9-32V	90	7.5A
CTL-TPX1840	9111193	18	40°	6.61 lb	9,504 lm	6,660 lm	9-32V	90	7.5A

CTL-TPX1810 | 9111018 - 10° BEAM

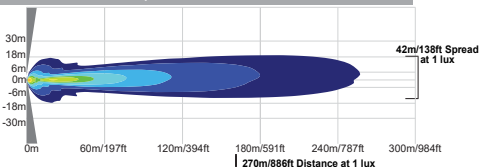

CTL-TPX1840 | 9111193 - 40° BEAM

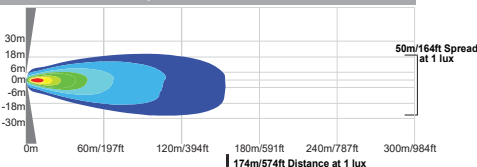

OPTIMUS

ITEM #	PART #	QTY	HOUSING	BEAM	WEIGHT	RAW LUMENS	EFFECTIVE LUMENS	INPUT VOLTS	WATTS	AMP DRAW
XIL-OPH115	9891699	1			1.37 lb	1,052 lm	736 lm			0.83A
XIL-OPH115KIT	9891705	2	Black	10°	2.74 lb	2,104 lm	1,473 lm	9-32V	10	1.67A
XIL-OPRH115	9891712	1			1.53 lb	1,052 lm	736 lm			0.83A
XIL-OPRH115KIT	9891729	2	Black	10°	3.06 lb	2,104 lm	1,473 lm	9-32V	10	1.67A
XIL-OP110	9123882	1			1.37 lb	1,052 lm	736 lm			0.83A
XIL-OP110KIT	9124421	2	Black	20°	2.74 lb	2,104 lm	1,473 lm	9-32V	10	1.67A
XIL-OP120	9130002	1			1.37 lb	1,052 lm	736 lm			0.83A
XIL-OP120KIT	9138015	2	Black	10°	2.74 lb	2,104 lm	1,473 lm	9-32V	10	1.67A
XIL-OP160	9124063	1			1.37 lb	1,052 lm	736 lm			0.83A
XIL-OP160KIT	9137926	2	Black	10°	2.74 lb	2,104 lm	1,473 lm	9-32V	10	1.67A
XIL-OP110W	9124513	1	White	10°	1.37 lb	1,052 lm	736 lm	9-32V	10	0.83A
XIL-OP110C	9124247	1	Chrome	10°	2.74 lb	2,104 lm	1,473 lm	9-32V	10	1.67A
XIL-OP120W	9139005	1	White	20°	1.37 lb	1,052 lm	736 lm	9-32V	10	0.83A
XIL-OP120C	9139098	1	Chrome	20°	2.74 lb	2,104 lm	1,473 lm	9-32V	10	1.67A
XIL-OP160W	9139364	1	White	60°	1.37 lb	1,052 lm	736 lm	9-32V	10	0.83A
XIL-OP160C	9139272	1	Chrome	60°	2.74 lb	2,104 lm	1,473 lm	9-32V	10	1.67A
XIL-OPR110	9140896	1			1.53 lb	1,052 lm	736 lm			0.83A
XIL-OPR110KIT	9141251	2	Black	10°	3.06 lb	2,104 lm	1,473 lm	9-32V	10	1.67A
XIL-OPR120	9141077	1			1.53 lb	1,052 lm	736 lm			0.83A
XIL-OPR120KIT	9141343	2	Black	10°	3.06 lb	2,104 lm	1,473 lm	9-32V	10	1.67A
XIL-OPR160	9141169	1			1.53 lb	1,052 lm	736 lm			0.83A
XIL-OPR160KIT	9141435	2	Black	10°	3.06 lb	2,104 lm	1,473 lm	9-32V	10	1.67A
XIL-OPR110W	9149172	1	White	10°	1.53 lb	1,052 lm	736 lm	9-32V	10	0.83A
XIL-OPR110C	9149080	1	Chrome	10°	3.06 lb	2,104 lm	1,473 lm	9-32V	10	1.67A
XIL-OPR120W	9149356	1	White	20°	1.53 lb	1,052 lm	736 lm	9-32V	10	0.83A
XIL-OPR120C	9149264	1	Chrome	20°	3.06 lb	2,104 lm	1,473 lm	9-32V	10	1.67A
XIL-OPR160W	9149530	1	White	60°	1.53 lb	1,052 lm	736 lm	9-32V	10	0.83A
XIL-OPR160C	9149448	1	Chrome	60°	3.06 lb	2,104 lm	1,473 lm	9-32V	10	1.67A
XIL-OP210	9124605	1			2.25 lb	2,104 lm	1,473 lm			1.67A
XIL-OP210KIT	9125053	2	Black	10°	4.5 lb	4,208 lm	2,946 lm	9-32V	20	3.3A
XIL-OP220	9139548	1			2.25 lb	2,104 lm	1,473 lm			1.67A
XIL-OP220KIT	9137834	2	Black	20°	4.5 lb	4,208 lm	2,946 lm	9-32V	20	3.3A
XIL-OP260	9136660	1			2.25 lb	2,104 lm	1,473 lm			1.67A
XIL-OP260KIT	9137742	2	Black	60°	4.5 lb	4,208 lm	2,946 lm	9-32V	20	3.3A
XIL-OP210W	9124964	1	White	10°	2.25 lb	2,104 lm	1,473 lm	9-32V	20	1.67A
XIL-OP210C	9124698	1	Chrome	10°	4.5 lb	4,208 lm	2,946 lm	9-32V	20	3.3A
XIL-OP220W	9139630	1	White	20°	2.25 lb	2,104 lm	1,473 lm	9-32V	20	1.67A
XIL-OP220C	9166636	1	Chrome	20°	4.5 lb	4,208 lm	2,946 lm	9-32V	20	3.3A
XIL-OP260W	9139722	1	White	60°	2.25 lb	2,104 lm	1,473 lm	9-32V	20	1.67A
XIL-OP260C	9159348	1	Chrome	60°	4.5 lb	4,208 lm	2,946 lm	9-32V	20	3.3A

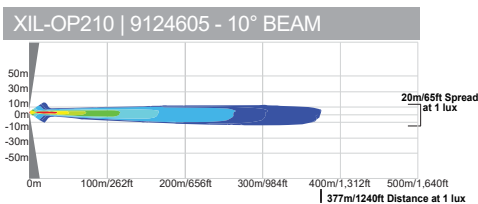
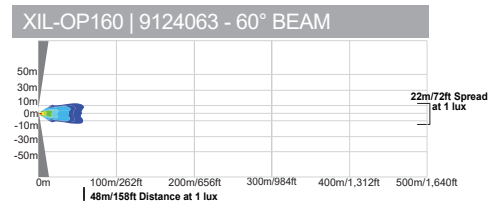
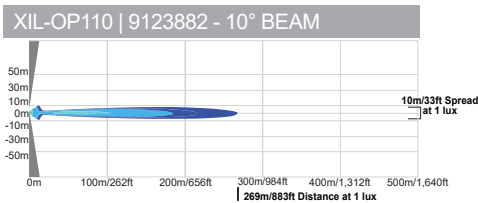

SOLO PRIME

ITEM #	PART #	HOUSING	BEAM	WEIGHT	RAW LUMENS	EFFECTIVE LUMENS	INPUT VOLTS	WATTS	AMP DRAW
XIL-SP110	4008830	Black	10°	0.70 lb	1,052 lm	736 lm	9-32V	10	0.83A
XIL-SP110W	4008847	White	10°	0.70 lb	1,052 lm	736 lm	9-32V	10	0.83A
XIL-SP120	4009882	Black	20°	0.70 lb	1,052 lm	736 lm	9-32V	10	0.83A
XIL-SP120W	4008854	White	20°	0.70 lb	1,052 lm	736 lm	9-32V	10	0.83A
XIL-SP140	4009899	Black	40°	0.70 lb	1,052 lm	736 lm	9-32V	10	0.83A
XIL-SP140W	4008861	White	40°	0.70 lb	1,052 lm	736 lm	9-32V	10	0.83A

XIL-SP110 | 4008830 - 10° BEAM

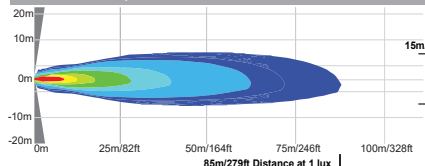

XIL-SP120 | 4009882 - 20° BEAM

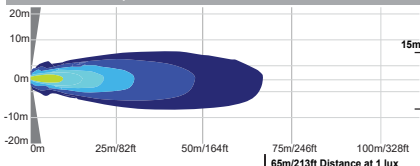

XIL-SP140 | 4009899 - 40° BEAM

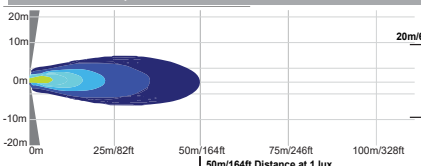

SOLSTICE SOLO

ITEM #	PART #	HOUSING	BEAM	WEIGHT	RAW LUMENS	EFFECTIVE LUMENS	INPUT VOLTS	WATTS	AMP DRAW
XIL-S1110	9888156	Black	10°	0.76 lb	1,052 lm	736 lm	9-32V	10	0.83A
XIL-S1110W	9888194	White	10°	0.76 lb	1,052 lm	736 lm	9-32V	10	0.83A
XIL-S1130	9888163	Black	30°	0.76 lb	1,052 lm	736 lm	9-32V	10	0.83A
XIL-S1130W	9888200	White	30°	0.76 lb	1,052 lm	736 lm	9-32V	10	0.83A
XIL-S1160	9888170	Black	60°	0.76 lb	1,052 lm	736 lm	9-32V	10	0.83A
XIL-S1160W	9888217	White	60°	0.76 lb	1,052 lm	736 lm	9-32V	10	0.83A
XIL-S11e3065	9888187	Black	30°x65°	0.76 lb	1,052 lm	736 lm	9-32V	10	0.83A
XIL-S11e3065W	9888224	White	30°x65°	0.76 lb	1,052 lm	736 lm	9-32V	10	0.83A

XIL-S1110 | 9888156 - 10° BEAM

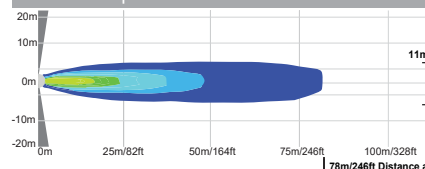

XIL-S1130 | 9888163 - 30° BEAM

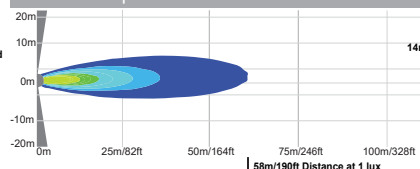

XIL-S1160 | 9888170 - 60° BEAM

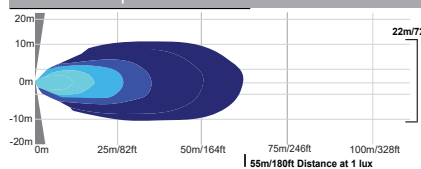

MINI SOLO

ITEM #	PART #	HOUSING	BEAM	WEIGHT	RAW LUMENS	EFFECTIVE LUMENS	INPUT VOLTS	WATTS	AMP DRAW
XIL-MX110	9113531	Black	10°	0.40 lb	528 lm	368 lm	9-32V	5	0.42A
XIL-MX140	9113715	Black	40°	0.40 lb	528 lm	368 lm	9-32V	5	0.42A
XIL-MX160	9113807	Black	60°	0.40 lb	528 lm	368 lm	9-32V	5	0.42A

XIL-MX110 | 9113531 - 10° BEAM

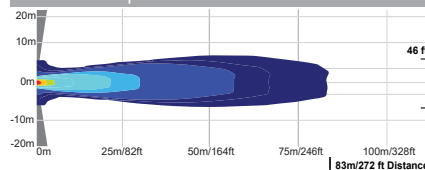

XIL-MX140 | 9113715 - 40° BEAM

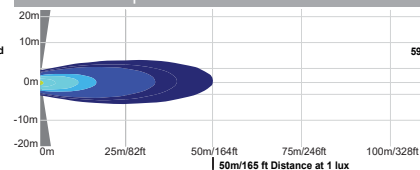

XIL-MX160 | 9113807 - 60° BEAM

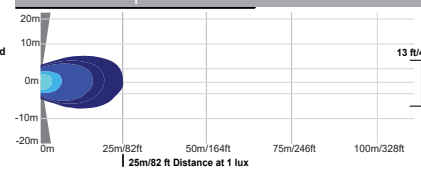



LIGHT BARS

XMITTER PRIME XTREME



BEAM PATTERNS 10°, 40°, Mixed	WARRANTY Extended
HEIGHT 3.75" / 95mm	WIDTH 3.31" / 84mm

END CAP MOUNTS



ITEM #: XIL-PECM Shown
PART #: 9889191

2D VIEW

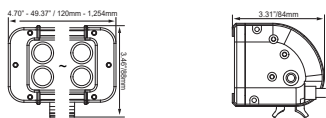

AVAILABLE IN AMBER



BRIGHTEST LIGHT BAR ON THE MARKET

- Full Range Fills In Road Way
- Plug And Play Harness Included
- PWM Integrated Dimming Circuitry
- 90% Efficiency Next Generation LED
- Electronic Thermal Management & Dimming



LENGTH
4.70" / 120mm
7.90" / 201mm
11.10" / 282mm
17.50" / 444mm
20.60" / 525mm
30.20" / 768mm
39.80" / 1,011mm
49.37" / 1,254mm

ITEM #	PART #	BEAM
XIL-PX610	9117409	10° Spot
XIL-PX1210	9115603	10° Spot
XIL-PX1810	9115788	10° Spot
XIL-PX3010	9116860	10° Spot
XIL-PX3610	9117041	10° Spot
XIL-PX5410	9117225	10° Spot
XIL-PX7210	9117584	10° Spot
XIL-PX9010	9887036	10° Spot

ITEM #	PART #	BEAM
XIL-PX640	9117492	40° Flood
XIL-PX1240	9115696	40° Flood
XIL-PX1840	9115870	40° Flood
XIL-PX3040	9116952	40° Flood
XIL-PX3640	9117133	40° Flood
XIL-PX5440	9117317	40° Flood
XIL-PX7240	9117676	40° Flood
XIL-PX9040	9887043	40° Flood

ITEM #	PART #	BEAM
XIL-PX6M	9894850	Mixed
XIL-PX12M	9894751	Mixed
XIL-PX18M	9887890	Mixed
XIL-PX30M	9123431	Mixed
XIL-PX36M	9894836	Mixed
XIL-PX54M	9153223	Mixed
XIL-PX72M	9153490	Mixed
XIL-PX90M	9132792	Mixed

*Additional Part Numbers & Technical Information On Page 28

XPR-S



UPGRADED FOR UNSURPASSED DISTANCE

- Halo Models Available
- Dual Mounting Standard
- Plug And Play Harness Included
- 40-95% More Distance than XPR Series
- Upgraded IRIS Reflector Technology With 10 Watt LED

BEAM PATTERNS Straight (6.5°)	WARRANTY Extended
HEIGHT 3.75" / 95mm	WIDTH 3.19" / 81mm

END CAP MOUNTS



ITEM #: XPI-EM Shown
PART #: 9892917

2D VIEW

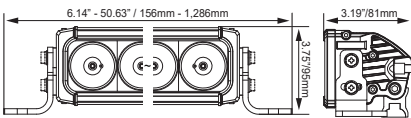

ITEM #	PART #	LENGTH	BEAM
XPR-3S	9897462	6.14" / 156 mm	Straight
XPR-6S	9897479	11.46"/291mm	Straight
XPR-9S	9897455	18.80"/476mm	Straight
XPR-12S	9897394	24.06"/611mm	Straight
XPR-15S	9897400	29.37"/746mm	Straight
XPR-18S	9897417	34.69"/881mm	Straight
XPR-21S	9897424	40.00"/1,016mm	Straight
XPR-27S	9897448	50.63"/1,286mm	Straight

SIDE WING MOUNTS INCLUDED



DUAL MOUNTING INCLUDED

Each XPR comes packaged with dual side-wing mounts as well as patented feet mounts. Amount of feet mounts vary by length of the light bar.

*Additional Part Numbers & Technical Information On Page 27

XPR



BEAM PATTERNS Straight, Tilted	WARRANTY Extended
HEIGHT 3.75" / 95mm	WIDTH 3.19" / 81mm

IRIS REFLECTORS FOR ULTIMATE DISTANCE

- Dual Mounting Standard
- 5-Watt XPI Light Bar Available
- Plug And Play Harness Included
- IRIS Reflector Technology With 10 Watt LED
- New Lifespan-Boosting Heat Sink Technology

END CAP MOUNTS



ITEM #: XPI-EM Shown
PART #: 9892917

2D VIEW

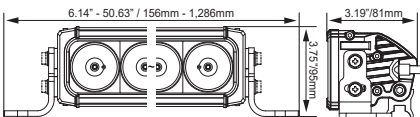

ITEM #	PART #	LENGTH	BEAM
XPR-3	9891606	6.05" / 153.7mm	Straight
XPR-6	9891613	11.46"/291mm	Straight
XPR-9M	9891620	18.80"/476mm	Tilted
XPR-12M	9891637	24.06"/611mm	Tilted
XPR-15M	9891644	29.37"/746mm	Tilted
XPR-18M	9891651	34.69"/881mm	Tilted
XPR-21M	9891668	40.00"/1,016mm	Tilted
XPR-27M	9891682	50.63"/1,286mm	Tilted

SIDE WING MOUNTS INCLUDED



DUAL MOUNTING INCLUDED

Each XPR comes packaged with dual side-wing mounts as well as patented feet mounts. Amount of feet mounts vary by length of the light bar.

*Additional Part Numbers & Technical Information On Page 28

XMITTER LOW PRO XTREME

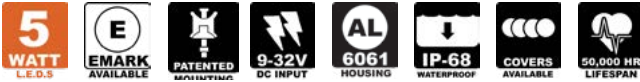

BEAM PATTERNS 10°, 40°, Mixed	WARRANTY Extended
HEIGHT 2.06" / 52mm	WIDTH 2.45" 62mm

XTREME OUTPUT IN A COMPACT LIGHT BAR

- Sleek Low Profile Design
- 90% Efficiency Next Gen LED
- Plug And Play Harness Included
- PWM Integrated Dimming Circuitry
- Electronic Thermal Management & Dimming

END CAP MOUNTS



ITEM #: XIL-LPECM Shown
PART #: 9888811

AVAILABLE IN AMBER



2D VIEW

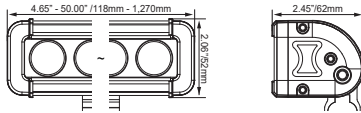

LENGTH
4.65" / 118mm
8.43" / 214mm
12.21" / 310mm
19.77" / 502mm
31.11" / 790mm
34.89" / 886mm
42.44" / 1,078mm
50.00" / 1,270mm

ITEM #	PART #	BEAM
XIL-LPX310	4000759	10° Spot
XIL-LPX610	9118758	10° Spot
XIL-LPX910	4000773	10° Spot
XIL-LPX1510	9114613	10° Spot
XIL-LPX2410	9121901	10° Spot
XIL-LPX2710	9114972	10° Spot
XIL-LPX3310	9115153	10° Spot
XIL-LPX3910	9128115	10° Spot

ITEM #	PART #	BEAM
XIL-LPX340	4000766	40° Flood
XIL-LPX640	9120737	40° Flood
XIL-LPX940	4000780	40° Flood
XIL-LPX1540	9114705	40° Flood
XIL-LPX2440	9132884	40° Flood
XIL-LPX2740	9115061	40° Flood
XIL-LPX3340	9115245	40° Flood
XIL-LPX3940	9132976	40° Flood

ITEM #	PART #	BEAM
XIL-LPX6M	9153407	Mixed
XIL-LPX15M	9897042	Mixed
XIL-LPX24M	9889351	Mixed
XIL-LPX39M	9892252	Mixed

*Additional Part Numbers & Technical Information On Page 29

XMITTER

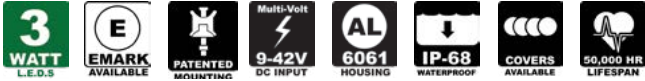

BEAM PATTERNS Euro, Flood	WARRANTY Extended
HEIGHT 2.76" / 69mm	WIDTH 3.00" / 76mm

END CAP MOUNTS



ITEM #: XIL-ECM Shown
PART #: 9888781

2D VIEW

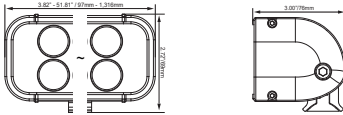

ORIGINAL LIGHT BAR WITH SEAMLESS BEAM

- Seamless Beam Pattern
- Plug and Play Harness Included
- Weatherproof Deutsch Connector
- Used by NASA, Border Patrol, and Pro Racers
- Infrared, Amber, Red Blue, and Green Available



ITEM #	PART #	LENGTH	BEAM
XIL-40	4006270	4.00" / 101.6mm	Euro
XIL-80	4006287	5.80" / 147.6mm	Euro
XIL-120	4006294	7.80" / 198.4mm	Euro
XIL-200	4006300	11.80" / 300mm	Euro
XIL-320	4006317	17.60" / 446mm	Euro
XIL-400	4006324	21.70" / 550mm	Euro
XIL-600	4006331	31.80" / 808mm	Euro
XIL-800	4006348	41.80" / 1,062mm	Euro
XIL-1000	4006355	51.80" / 1,316mm	Euro

ITEM #	PART #	LENGTH	BEAM
XIL-41	4007529	4.00" / 101.6mm	Flood
XIL-81	4007581	5.80" / 147.6mm	Flood
XIL-121	4007369	7.80" / 198.4mm	Flood
XIL-201	4007468	11.80" / 300mm	Flood
XIL-321	4007482	17.60" / 446mm	Flood
XIL-401	4007505	21.70" / 550mm	Flood
XIL-601	4007543	31.80" / 808mm	Flood
XIL-801	4007567	41.80" / 1,062mm	Flood
XIL-1001	4007345	51.80" / 1,316mm	Flood

*Additional Part Numbers & Technical Information On Page 29

CHASER BARS



BEAM PATTERNS 60°	WARRANTY Extended
HEIGHT 2.06" / 52mm	WIDTH 2.45" / 62mm

LOW PROFILE REAR LED CHASER BAR SYSTEM

- Sleek Low Profile Design
- High Output Color LEDs
- Racer Models Include Blue LEDs
- Running and Brake Lights in Single Bar
- Red, Amber, and White LEDs in Single Housing

END CAP MOUNTS



ITEM #: XIL-LPECM Shown
PART #: 9888811

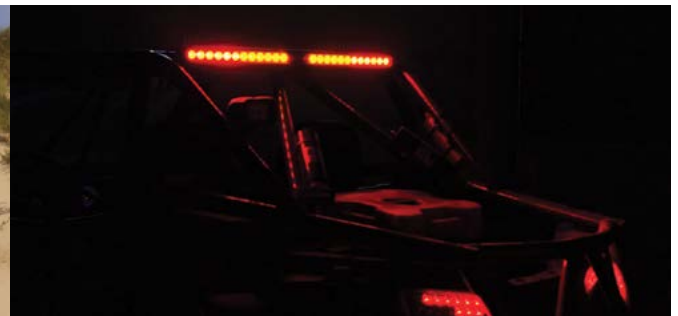

ITEM #	PART #	LENGTH	USE
XIL-CBSR21	9897196	27.33" / 694mm	Recreation
XIL-CBSR27	9897202	34.89" / 886mm	Recreation

ITEM #	PART #	LENGTH	USE
XIL-CBSX21	9897219	27.33" / 694mm	Race
XIL-CBSX27	9897226	34.89" / 886mm	Race

XPR-S TECHNICAL DATA

ITEM #	PART #	LEDS	BEAM	LENGTH	WEIGHT	RAW LUMENS	EFFECTIVE LUMENS	INPUT VOLTS	WATTS	AMP DRAW
XPR-3S	9897462	3	Straight	6.14"/156mm	1.80lb/0.82kg	3,237 lm	2,266 lm	11-32V	30	2.5A
XPR-6S	9897479	6	Straight	11.46"/291mm	3.40lb/1.54kg	6,474 lm	4,531 lm	11-32V	60	5A
XPR-9S	9897455	9	Straight	18.80"/476mm	5.10lb/2.31kg	9,711 lm	6,798 lm	11-32V	60	5A
XPR-12S	9897394	12	Straight	24.06"/611mm	6.90lb/3.13kg	12,948 lm	9,064 lm	11-32V	90	10A
XPR-15S	9897400	15	Straight	29.37"/746mm	8.70lb/3.95kg	16,185 lm	11,330 lm	11-32V	150	12.5A
XPR-18S	9897417	18	Straight	34.69"/881mm	9.80lb/4.45kg	19,422 lm	13,595 lm	11-32V	180	15A
XPR-21S	9897424	21	Straight	40.00"/1,016mm	11.60lb/5.26kg	22,659 lm	15,861 lm	11-32V	210	17.5A
XPR-27S	9897448	27	Straight	50.63"/1,286mm	15.22lb/6.90kg	29,133 lm	20,393 lm	11-32V	270	22.5A

XPR-27S | 9891682 - Straight Beam

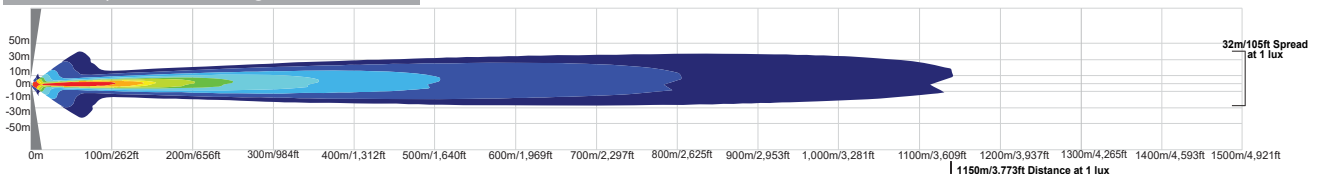

XMITTER PRIME XTREME

ITEM #	PART #	LEDS	BEAM	LENGTH	WEIGHT	RAW LUMENS	EFFECTIVE LUMENS	INPUT VOLTS	WATTS	AMP DRAW
XIL-PX610	9117409		10°							
XIL-PX640	9117492	6	40°	4.70"/120mm	2.65lb/1.2kg	3,168 lm	2,220 lm	9-32V	30	2.5A
XIL-PX6M	9894850		Mixed							
XIL-PX1210	9115603		10°							
XIL-PX1240	9115696	12	40°	7.90"/201mm	5.29lb/2.4kg	6,336 lm	4,440 lm	9-32V	60	5A
XIL-PX12M	9894751		Mixed							
XIL-PX1810	9115788		10°							
XIL-PX1840	9115870	18	40°	11.10"/282mm	6.61lb/3.0kg	9,504 lm	6,660 lm	9-32V	90	7.5A
XIL-PX18M	9887890		Mixed							
XIL-PX3010	9116860		10°							
XIL-PX3040	9116952	30	40°	17.50"/444mm	9.25lb/4.5kg	15,840 lm	11,100 lm	9-32V	150	12.5A
XIL-PX30M	9123431		Mixed							
XIL-PX3610	9117041		10°							
XIL-PX3640	9117133	36	40°	20.60"/525mm	10.58lb/4.8kg	19,008 lm	13,320 lm	9-32V	180	15A
XIL-PX36M	9894836		Mixed							
XIL-PX5410	9117225		10°							
XIL-PX5440	9117317	54	40°	30.20"/768mm	14.55lb/6.6kg	28,512 lm	19,980 lm	9-32V	270	22.5A
XIL-PX54M	9153223		Mixed							
XIL-PX7210	9117584		10°							
XIL-PX7240	9117676	72	40°	39.80"/1,011mm	18.51lb/8.4kg	38,016 lm	26,640 lm	9-32V	360	30A
XIL-PX72M	9153490		Mixed							
XIL-PX9010	9887036		10°							
XIL-PX9040	9887043	90	40°	49.37"/1,254mm	22.49lb/10.2kg	47,520 lm	33,300 lm	9-32V	450	37.5A
XIL-PX90M	9132792		Mixed							

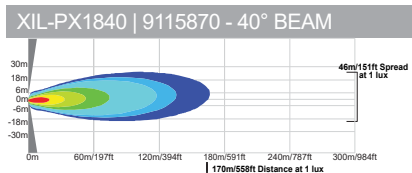
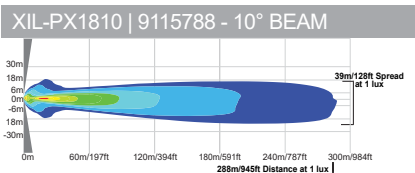

XPR

ITEM #	PART #	LEDS	BEAM	LENGTH	WEIGHT	RAW LUMENS	EFFECTIVE LUMENS	INPUT VOLTS	WATTS	AMP DRAW
XPR-3	9891606	3	Straight	6.14"/156mm	1.80lb/0.82kg	3,237 lm	2,266 lm	11-32V	30	2.5A
XPR-6	9891613	6	Straight	11.46"/291mm	3.40lb/1.54kg	6,474 lm	4,531 lm	11-32V	60	5A
XPR-9M	9891620	9	Tilted	18.80"/476mm	5.10lb/2.31kg	9,711 lm	6,798 lm	11-32V	60	5A
XPR-12M	9891637	12	Tilted	24.06"/611mm	6.90lb/3.13kg	12,948 lm	9,064 lm	11-32V	90	7.5A
XPR-15M	9891644	15	Tilted	29.37"/746mm	8.70lb/3.95kg	16,185 lm	11,330 lm	11-32V	150	12.5A
XPR-18M	9891651	18	Tilted	34.69"/881mm	9.80lb/4.45kg	19,422 lm	13,595 lm	11-32V	180	15A
XPR-21M	9891668	21	Tilted	40.00"/1,016mm	11.60lb/5.26kg	22,659 lm	15,861 lm	11-32V	210	17.5A
XPR-27M	9891682	27	Tilted	50.63"/1,286mm	15.22lb/6.90kg	29,133 lm	20,393 lm	11-32V	270	22.5A

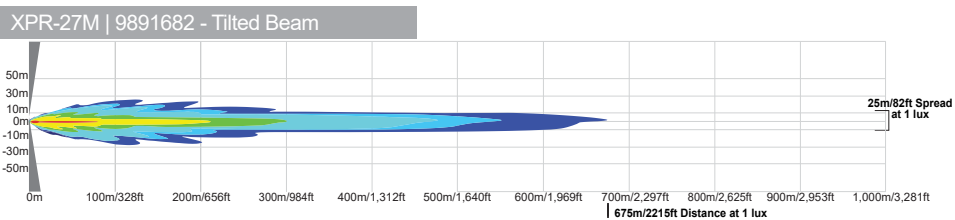

XMITTER LOW PROFILE XTREME

ITEM #	PART #	LEDS	BEAM	LENGTH	WEIGHT	RAW LUMENS	EFFECTIVE LUMENS	INPUT VOLTS	WATTS	AMP DRAW
XIL-LPX310 XIL-LPX340	4000759 4000766	3	10° 40°	4.65"/118mm	1.21lb/0.5kg	1,584 lm	1,110 lm	9-32V	15	1.25A
XIL-LPX610 XIL-LPX640 XIL-LPX6M	9118758 9120737 9153407	6	10° 40° Mixed	8.43"/214mm	2.00lb/0.9kg	3,168 lm	2,220 lm	9-32V	30	2.5A
XIL-LPX910 XIL-LPX940	4000773 4000780	9	10° 40°	12.21"/310mm	2.84lb/1.3kg	4,752 lm	3,330 lm	9-32V	45	3.75A
XIL-LPX1510 XIL-LPX1540 XIL-LPX15M	9114613 9114705 9897042	15	10° 40° Mixed	19.77"/502mm	4.45lb/2.0kg	7,920 lm	5,550 lm	9-32V	75	6.25A
XIL-LPX2410 XIL-LPX2440 XIL-LPX24M	9121901 9132884 9889351	24	10° 40° Mixed	31.11"/790mm	6.05lb/2.7kg	12,672 lm	8,880 lm	9-32V	120	10A
XIL-LPX2710 XIL-LPX2740	9114972 9115061	27	10° 40°	34.89"/886mm	7.67lb/3.5kg	14,256 lm	9,990 lm	9-32V	135	11.25A
XIL-LPX3310 XIL-LPX3340	9115153 9115245	33	10° 40°	42.44"/1,078mm	9.26lb/4.2kg	17,424 lm	12,210 lm	9-32V	165	13.75A
XIL-LPX3910 XIL-LPX3940 XIL-LPX39M	9128115 9132976 9892252	39	10° 40° Mixed	50.00"/1,270mm	10.9lb/4.9kg	20,592 lm	14,430 lm	9-32V	195	16.25A

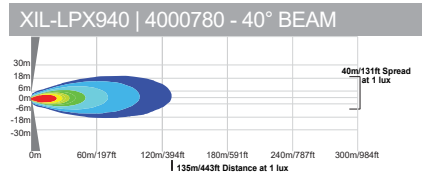
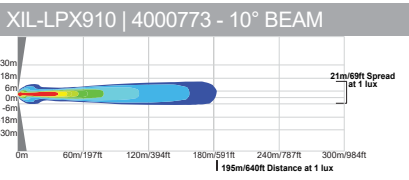

XMITTER

ITEM #	PART #	LEDS	BEAM	LENGTH	WEIGHT	RAW LUMENS	EFFECTIVE LUMENS	INPUT VOLTS	WATTS	AMP DRAW
XIL-40 XIL-41	4006270 4007529	4	Euro Flood	4.00"/101.6mm	1.26lb/0.57kg	720 lm	396 lm	9-42V	12	1.25A
XIL-80 XIL-81	4006287 4007581	8	Euro Flood	5.80"/147.6mm	2.09lb/0.95kg	1,440 lm	792 lm	9-42V	24	2.5A
XIL-120 XIL-121	4006294 4007369	12	Euro Flood	7.80"/198.4mm	2.65lb/1.2kg	2,160 lm	1,188 lm	9-42V	36	3.75A
XIL-200 XIL-201	4006300 4007468	20	Euro Flood	11.80"/300mm	3.64lb/1.65kg	3,600 lm	1,980 lm	9-42V	60	6.25A
XIL-320 XIL-321	4006317 4007482	32	Euro Flood	17.60"/446mm	5.51lb/2.5kg	5,760 lm	3,168 lm	9-42V	96	10A
XIL-400 XIL-401	4006324 4007505	40	Euro Flood	21.70"/550mm	6.61lb/3.0kg	7,200 lm	3,960 lm	9-42V	120	11.25A
XIL-600 XIL-601	4006331 4007543	60	Euro Flood	31.80"/808mm	9.59lb/4.35kg	10,800 lm	5,940 lm	9-42V	180	13.75A
XIL-800 XIL-801	4006348 4007567	80	Euro Flood	41.80"/1,062mm	12.46lb/5.65kg	14,400 lm	7,920 lm	9-42V	240	16.25A
XIL-1000 XIL-1001	4006355 4007345	100	Euro Flood	51.80"/1,316mm	14.55lb/6.60kg	18,000 lm	9,900 lm	9-42V	300	16.25A

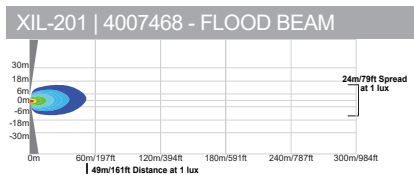
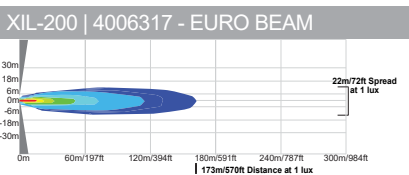

VEHICLE SPECIFIC KITS

JEEP KITS

ABOUT JEEP JK KITS

Adding custom lighting takes any Jeep to the next level. Vision X makes easy to install custom kits for Jeep JK vehicles. All kits feature no-drilling installation, and are easily installed in a matter of minutes.



AVAILABLE JEEP LED KITS



Factory Fog Light Upgrade Kit
 - 883' Of Usable Light per Light
 - 7x Brighter Than Factory
 - Direct Replacement

ITEM #: XIL-OE1012JKV2OPR Shown
 PART #: 9154756



Windshield Mount for Light Bars
 - Mount 50" LED Light Bars
 - Easy Installation
 - No Drilling

ITEM #: XIL-OEW0713JKV2 Shown
 PART #: 9888422



Hood Mount for Light Bars
 - Maintains Factory Appearance
 - For Up To 20" LED Light Bar
 - Adds Up To 19,008 Lumens

ITEM #: XIL-OEH0713JKPX36 Shown
 PART #: 9891002



A-Pillar Light Mount
 - Perfect For Cannon Or Optimus
 - Long Range Projection
 - No Drilling Required

ITEM #: XIL-OEA0713JKCPZ1 Shown
 PART #: 9888415

DIRECT REPLACEMENT LED UPGRADES

No Drilling Necessary | Direct Plug-And-Play With Factory Wiring | Dramatically Increase Visibility

ITEM #	PART #	APPLICATION	YEAR FITS	KIT INCLUDES	REFERENCE
XIL-OE0709JKV2	9145662	LED FOG LIGHTS	07-09 JEEP JK	Brackets, Connectors	-
XIL-OE1012JKV2	9154664	LED FOG LIGHTS	10-17 JEEP JK	Brackets, Connectors	-
XIL-OE0709JKV2OPR	9145754	LED FOG LIGHTS	07-09 JEEP JK	Brackets, (2) XIL-OPR110, Connectors	PAGE 39
XIL-OE1012JKV2OPR	9154756	LED FOG LIGHTS	10-17 JEEP JK	Brackets, (2) XIL-OPR110, Connectors	PAGE 39
XIL-OE13JKX	9891064	LED FOG LIGHTS	13-17 JEEP JK-X	Brackets, Connectors	-
XIL-OEW0713JKV2	9888422	WINDSHIELD MOUNT	07-17 JEEP JK	Brackets	-
XIL-OEH0713PX36	9891002	HOOD LIGHT BAR	07-17 JEEP JK	Brackets, (1) XIL-PX3610, Harness	-
XIL-OEH0713JKXP112	9891019	HOOD LIGHT BAR	07-17 JEEP JK	Brackets, (1) XPI-12M	PAGE 39
XIL-OEA0713JK	9888392	A-PILLAR FOG LIGHT	07-17 JEEP JK	Brackets	-
XIL-OEA0713JKOP1	9888408	A-PILLAR FOG LIGHT	07-17 JEEP JK	Brackets, (2) XIL-OP110, Harness	-
XIL-OEA0713JKCPZ1	9888415	A-PILLAR FOG LIGHT	07-17 JEEP JK	Brackets, (2) CTL-CPZ110, Harness	PAGE 38
XIL-OEA9706TJCPZ1	9892795	A-PILLAR FOG LIGHT	97-06 JEEP TJ	Brackets, (2) CTL-CPZ110, Harness	PAGE 38
XIL-OEA9706TJOPH	9892818	A-PILLAR FOG LIGHT	97-06 JEEP TJ	Brackets, (2) XIL-OPH115, Harness	-

FORD RAPTOR KITS



Factory Fog Light Upgrade Kit
ITEM #: XIL-OE10FROP Shown
PART #: 9133515



Bumper Mount for Light Bars
ITEM #: XIL-OEB10FRPX3610 Shown
PART #: 9887357

FACTORY FOG LIGHT UPGRADE KIT

Lights, Mounts, Wiring | 7x Brighter Than Headlight | Direct Fit In Factory Opening

ITEM #	PART #	FITS	KIT INCLUDES	REFERENCE
XIL-OE10FR	9160870	10-14 FORD RAPTOR	BRACKET, FACTORY INTEGRATION HARNESS	-
XIL-OE10FROP	9133515	10-14 FORD RAPTOR	BRACKETS, (4) XIL-OP110, INTEGRATED HARNESS	PAGE 41
XIL-OE10FROPH	9892450	10-14 FORD RAPTOR	BRACKETS, (4) XIL-OPH115, INTEGRATED HARNESS	PAGE 41

BUMPER MOUNT FOR LIGHT BARS

Lights, Mounts, Wiring | Fits Directly into Factory Bumper | Add Up to 19,008 Lumens

ITEM #	PART #	FITS	KIT INCLUDES	REFERENCE
XIL-OEB10FR	9887340	10-14 FORD RAPTOR	BRACKETS, FACTORY INTEGRATION HARNESS	-
XIL-OEB10FRPX3610	9887357	10-14 FORD RAPTOR	BRACKETS, (1) XIL-PX3610, INTEGRATED HARNESS	PAGE 42

FORD F SERIES KITS



Factory Fog Light Upgrade Kit
ITEM #: XIL-OE9913FSDDURA Shown
PART #: 9891200



Bumper Mount for Light Bars
ITEM #: XIL-OEB09F150PX36 Shown
PART #: 9891156

FACTORY FOG LIGHT UPGRADE KIT

Drastically Increase Light Output | 99-16 Ford Super Duty Models | Direct Fit In Factory Bumper

ITEM #	PART #	FITS	KIT INCLUDES	REFERENCE
XIL-OE9913FSD	9891194	99-16 FORD SUPER DUTY	BRACKET, CONNECTORS	-
XIL-OE9913FSDDURA	9891200	99-16 FORD SUPER DUTY	BRACKETS, (2) DURA-410, CONNECTORS	PAGE 41

BUMPER MOUNT FOR LIGHT BARS

EcoBoost Edition Available | Add Up To 19,008 Lumens | Direct Fit In Factory Bumper

ITEM #	PART #	FITS	KIT INCLUDES	REFERENCE
XIL-OEB09F150	9891057	09-14 FORD F150	BRACKET	-
XIL-OEB09F150PX36	9891156	09-14 FORD F150	BRACKET, XIL-PX3610, WIRING HARNESS	PAGE 42
XIL-OEB09F150LPX15	9891163	09-14 FORD F150	BRACKET, XIL-LPX1510, WIRING HARNESS	-
XIL-OEB09F150ECO	9891170	09-14 FORD F150	BRACKET, (2) XIL-PX610, WIRING HARNESS	PAGE 42

DODGE RAM KITS



ITEM #: XIL-OE0913DROP1MX2 Shown
PART #: 9890685

FACTORY FOG LIGHT UPGRADE KIT

Lights, Mounts, Wiring | Available for 02-14 Dodge Ram Models | Direct Fog Light Replacement

ITEM #	PART #	FITS	KIT INCLUDES
XIL-OE0210DR	4002333	02-08 DODGE RAM	BRACKETS, PLUG & PLAY CONNECTORS
XIL-OE0210DRUMX	9133065	02-08 DODGE RAM	BRACKETS, (2) XIL-UMX4010, CONNECTORS
XIL-OE0913DR	9889221	09-14 DODGE RAM	BRACKETS, CONNECTORS
XIL-OE0913DROP	9888552	09-14 DODGE RAM	BRACKETS, (2) XIL-OP110, CONNECTORS
XIL-OE0913DROP1MX2	9890685	09-14 DODGE RAM	BRACKETS, (2) XIL-OP110, (2)XIL-OP120 CONNECTORS



ITEM #: XIL-OEB0913DRPX3610 Shown
PART #: 9889245

BUMPER MOUNT FOR LIGHT BARS

Lights, Mounts, Wiring | Add Up to 19,008 Lumens | Direct Fit In Factory Bumper

ITEM #	PART #	FITS	KIT INCLUDES
XIL-OEB0913DR	9889238	10-14 DODGE RAM	BRACKETS, CONNECTORS
XIL-OEB0913DRPX3610	9889245	10-14 DODGE RAM	BRACKETS, XIL-PX3610, WIRING HARNESS

TOYOTA TUNDRA KITS



ITEM #: XIL-OE0711TTUMX Shown
PART #: 9133249

FACTORY FOG LIGHT UPGRADE KIT

Lights, Mounts, Wiring | 7x Brighter Than Headlight | Direct Fog Light Replacement

ITEM #	PART #	FITS	KIT INCLUDES
XIL-OE0711TT	4002296	07-13 TUNDRA	BRACKET , CONNECTORS
XIL-OE0711TTUMX	9133249	07-13 TUNDRA	BRACKETS, (2) XIL-UMX4010, CONNECTORS

GMC SIERRA KITS



ITEM #: XIL-OE0111GSUMX Shown
PART #: 9133157

FACTORY FOG LIGHT UPGRADE KIT

Lights, Mounts, Wiring | Bolts Directly To Factory Mounting | 7x Brighter Than Headlight

ITEM #	PART #	FITS	KIT INCLUDES
XIL-OE0711GS	4002388	07-13 GMC SIERRA	BRACKET
XIL-OE0711GSUMX	9133157	07-13 GMC SIERRA	BRACKETS, (2) XIL-UMX4010, T-TAP CONNECTORS

CHEVROLET SILVERADO KITS



ITEM #: XIL-OE0711CSS1100 Shown
PART #: 9120829

FACTORY FOG LIGHT UPGRADE KIT

Lights, Mounts, Wiring | Bolts Directly To Factory Mounting | 7x Brighter Than Headlight

ITEM #	PART #	FITS	KIT INCLUDES
XIL-OE0711CS	4002340	07-13 SILVERADO	BRACKETS*, T-TAP CONNECTORS
XIL-OE0711CSS1100	9120829	07-13 SILVERADO	BRACKETS, (4) XIL-S1100, T-TAP CONNECTORS

POLARIS RZR KITS

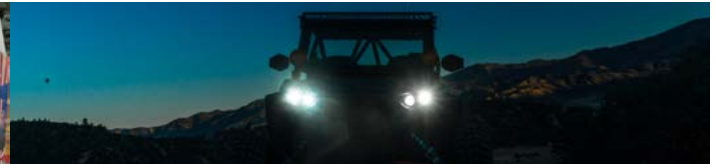

Twin LED Headlight System
 ITEM #: XIL-OEHL08RZR900OP Shown
 PART #: 9898582



A Pillar Mounting Brackets
 ITEM #: XIL-OEAD08RZR0PR Shown
 PART #: 9898940



D Pillar Mounting Brackets
 ITEM #: XIL-OED08RZR0PR Shown
 PART #: 9898988

TWIN LED HEADLIGHT SYSTEM FOR POLARIS RZR

08+ Models | Halo Models Available | Plug and Play Wiring Included | Maintains Separate High / Low Beam Operation

ITEM #	PART #	LIGHTS INCLUDED	KIT INCLUDES
XIL-OEHL08RZR900	9898643	No	Left and Right Brackets, 2 Wiring Adapters
XIL-OEHL08RZR900OP	9898582	Yes, Black Housing	4x XIL-OP110 Lights, Left and Right Brackets, 2 Wiring Adapters
XIL-OEHL08RZR900OPC	9898599	Yes, Chrome Housing	4x XIL-OP110C Lights, Left and Right Brackets, 2 Wiring Adapters
XIL-OEHL08RZR900OPW	9898629	Yes, White Housing	4x XIL-OP110W Lights, Left and Right Brackets, 2 Wiring Adapters
XIL-OEHL08RZR900OPH	9898605	Yes, Black with Halo	4x XIL-OPH115 Lights, Left and Right Brackets, 2 Wiring Adapters

TWIN LED HEADLIGHT SYSTEM FOR POLARIS RZR 1000

14+ Models | Halo Models Available | Plug and Play Wiring Included | Maintains Separate High / Low Beam Operation

ITEM #	PART #	LIGHTS INCLUDED	KIT INCLUDES
XIL-OEHL14RZR	9897509	No	Left and Right Brackets, 2 Wiring Adapters
XIL-OEHL14RZROPR	9897516	Yes, Black Housing	4x XIL-OPR110 Lights, Left and Right Brackets, 2 Wiring Adapters
XIL-OEHL14RZR0PRC	9898490	Yes, Chrome Housing	4x XIL-OPR110C Lights, Left and Right Brackets, 2 Wiring Adapters
XIL-OEHL14RZROPRW	9898513	Yes, White Housing	4x XIL-OPR110W Lights, Left and Right Brackets, 2 Wiring Adapters
XIL-OEHL14RZROPRH	9898520	Yes, Black with Halo	4x XIL-OPRH115 Lights, Left and Right Brackets, 2 Wiring Adapters

A-PILLAR LIGHT MOUNTS FOR OPTIMUS 2008+ POLARIS RZR

08+ Models | Single and Dual Light Brackets Available | Harness Included with Lights

ITEM #	PART #	LIGHTS INCLUDED	KIT INCLUDES
XIL-OEAS08RZR	9898957	No	Left and Right Brackets
XIL-OEAS08RZROPR	9898964	Yes, Black Housing	2x XIL-OPR110 Lights, Left and Right Single Light Brackets, Harness
XIL-OEAD08RZR	9898933	No	Left and Right Brackets
XIL-OEAD08RZROPR	9898940	Yes, Black Housing	4x XIL-OPR110 Lights, Left and Right Dual Light Brackets, 2x Harness

D-PILLAR LIGHT MOUNTS FOR OPTIMUS 2008+ POLARIS RZR

08+ Models | Light is Adjustable Once Mounted | Harness Included with Lights

ITEM #	PART #	LIGHTS INCLUDED	KIT INCLUDES
XIL-OED08RZR	9898971	No	Left and Right Brackets
XIL-OED08RZROPR	9898988	Yes, Black Housing	2x XIL-OPR110 Lights, Left and Right Single Light Brackets, Harness

YAMAHA YXZ

YAMAHA YXZ HEADLIGHT KIT

For Select 2015+ Models | 1 Kit for Low Beam 2nd Kit Optional for High Beam | Plug and Play Installation

ITEM #	PART #	LIGHTS INCLUDED	KIT INCLUDES
XIL-OEHL15YXZCPZ1	9899114	Yes, Black Housing	Brackets, 2 Cannon Lights

VIEW OUR WEBSITE FOR COMPLETE APPLICATION GUIDE AND THE NEWEST PRODUCTS

AUTOMOTIVE ACCESSORIES

AUTO ACCESSORIES AND KITS

ROOF LIGHT BARS



CHASER REAR LED



HEADLIGHT UPGRADES



A-PILLAR LIGHTS



BUMPER LIGHTS



ACCESSORIES



ROOF MOUNTED LIGHT BARS

THE XPR-S IS THE ULTIMATE RACE LIGHT BAR

All New IRIS Reflectors | XPR-21S Shines 3,281' of Useable Light | Available 5" to 51" Lengths



ITEM #: XPR-21S
PART #: 9897424

ITEM #	PART #	APPLICATION
XPR-15S	9897400	Stock cages 30"
XPR-21S	9897424	Aftermarket Cages 40"

See Page 27 for Complete XPR-S Details

XPR FEATURES TILTED REFLECTORS FOR A MIXED BEAM

Multiple Mounting Options Included | Highest Quality 10-Watt LED | Available 5" to 51" Lengths



ITEM #: XPR-21M
PART #: 9891668

ITEM #	PART #	FITS
XPR-15M	9891644	Stock cages 30"
XPR-21M	9891668	Aftermarket Cages 40"

See Page 28 for Complete XPR Details

HEADLIGHT UPGRADES



ITEM #: XIL-OEHL14RZROPR
PART #: 9897516

POLARIS RZR HEADLIGHT KIT

For Select 2008+ Models | Available in Black, Chrome, White and Halo Models | Plug and Play Installation

ITEM #	PART #	FITS	KIT INCLUDES
XIL-OEHL14RZROPR	9897516	2014+ RZR	Brackets, 4 Optimus Lights
XIL-OEHL08RZR900OP	9898582	2008+ RZR	Brackets, 4 Optimus Lights

See Page 33 for Complete RZR Headlight Details

YAMAHA YXZ HEADLIGHT KIT

For Select 2015+ Models | 1 Kit for Low Beam 2nd Kit Optional for High Beam | Plug and Play Installation

ITEM #	PART #	FITS	KIT INCLUDES
XIL-OEHL15YXZCPZ1	9899114	2015+ YXZ	Brackets, 2 Cannon Lights

View our website for complete application information

BUMPER LIGHTS



ITEM #: DURA-410KIT Shown
PART #: 9891187

DURA SERIES BUMPER LIGHT FOR UTVS

Add 4,244 Raw Lumens to Your UTV | Simple Single Stud Mounting | Adjustable Bracket for Easy Aiming

ITEM #	PART #	APPLICATION	KIT INCLUDES
DURA-410KIT	9891187	Spot Beam Kit	2 Lights and Harness

BUMPER LIGHT BARS FOR UTVS

Available in Flood or Spot Beams | Also Available with Amber LEDs | Add Light to Your Front Bumper



ITEM #: XIL-LP610A Shown
PART #: 9888071



ITEM #	PART #	APPLICATION	INCLUDES
XIL-LPX610	9118758	9" Spot Beam	Light Bar and Harness
XIL-LPX640	9120737	9" Flood Beam	Light Bar and Harness
XIL-LP610A	9888071	9" Amber Spot	Light Bar and Harness

CHASER REAR LED SYSTEM



ITEM #: XIL-CBSR27 Shown
PART #: 9897202

RECREATIONAL CHASER BAR

Low Profile Design | Running & Brake Lights In Single Bar | Red/Amber/White/Amber/Red Configuration

ITEM #	PART #	APPLICATION
XIL-CBSR21	9897196	Recreational 28"
XIL-CBSR27	9897202	Recreational 28"

See Page 27 for Complete Chaser Details



ITEM #: XIL-CBSX27 Shown
PART #: 9897196

RACER CHASER BAR

Low Profile Design | Running & Brake Lights In Single Bar | Feature Blue Warning Light

ITEM #	PART #	APPLICATION
XIL-CBSX21	9897219	Racer Xtreme 28"
XIL-CBSX27	9897226	Racer Xtreme 35"

See Page 27 for Complete Chaser Details

A-PILLAR LIGHTING



ITEM #: CTL-CPZ110KIT Shown
PART #: 9151069

4.5" LED LIGHT CANNON

Multiple Mounting Options | Lightweight Hybrid Housing | Plug and Play Installation

ITEM #	PART #	KIT INCLUDES
CTL-CPZ110KIT	9151069	2 x 25-Watt LED Light Cannons and Harness
CTL-CPZ110XPKIT	9893365	2 x 40-Watt LED Light Cannons and Harness

See Page 18 for Complete Cannon Details



SNAP-ON COVERS FOR CANNONS CHANGE BEAM AND COLOR

Clear Covers to Protect | Red Covers for Sand | Amber Covers for Fog and Debris

ITEM #	PART #	APPLICATION
PCV-CP1RCB	9893235	Red Combo Beam
PCV-CP1BL	9157450	Black Protective

See Page 47 for Complete Polycarbonate Cover Details

ACCESSORIES



ITEM #: XIL-PDW Shown
PART #: 9136127

PRO POD UNDER GLOW LIGHTING

Add Color to Your UTV | Extremely Low Power Consumption | Add Light to Your Front Bumper

ITEM #	PART #	COLOR
XIL-PDA	9136219	Amber
XIL-PDB	9136301	Blue
XIL-PDG	9136394	Green

ITEM #	PART #	COLOR
XIL-PDR	9136486	Red
XIL-PDW	9136127	White

See Page 48 for Complete Pro Pod Details

SECURITY HARDWARE

Secure Your Lights and Accessories



DURA MINI

2.75" Universal Flood Light



MINI SOLO

1.7" Pod Available in Colors



WINDSHIELD LIGHT BAR



FOG LIGHT UPGRADES



A-PILLAR



HOOD MOUNT



ACCESSORIES



WINDSHIELD LIGHT BARS

XMITTER PRIME XTREME MAX LIGHT OUTPUT LIGHT BAR

Mixed Beam for Wide Pattern | Mount Using End Caps Or Feet | Wiring Included



ITEM #: XIL-PX90M
PART #: 9132792

ITEM #	PART #	INCLUDES
XIL-PX90M	9132792	50" Mixed Beam PX Light Bar
XIL-OEW0713JKV2	9888422	Windshield Light Bar Mounting Brackets Only

See Page 28 for Complete PX Details

XPR LONG DISTANCE LIGHT BAR

Tilted Reflectors for Wide Pattern | Mount Using End Caps Or Feet | Wiring Included



ITEM #: XPR-27M Shown
PART #: 9891682

ITEM #	PART #	INCLUDES
XPR-27M	9891682	50" Tilted Reflector XPR Light Bar
XIL-OEW0713JKV2	9888422	Windshield Light Bar Mounting Brackets Only

See Page 28 for Complete XPR Details

A-PILLAR LIGHTING



ITEM #: XIL-OEA0713JKCPZ1 Shown
PART #: 9888415

JEEP A-PILLAR BRACKETS AND 4.5" LED LIGHT CANNON KITS

Multiple Mounting Options | Lightweight Hybrid Housing | Plug and Play Installation

ITEM #	PART #	KIT INCLUDES
XIL-OEA0713JKCPZ1	9888415	Brackets for Jeep JK and 2x 4.5" Light Cannon
XIL-OEA9706TJCPZ1	9892795	Brackets for Jeep TJ and 2x 4.5" Light Cannon

See Page 30 for Complete VX Spec Details

SNAP-ON COVERS FOR CANNONS CHANGE BEAM AND COLOR

Clear Covers to Protect | Red Covers for Sand | Amber Covers for Fog and Debris



ITEM #	PART #	APPLICATION
PCV-CP1RCB	9893235	4.5" Red Combo Beam Cover
PCV-CP1BL	9157450	4.5" Black Protective Cover

See Page 47 for Complete Polycarbonate Cover Details

FOG LIGHT UPGRADES



ITEM #: XIL-OE1012JKOPR Shown
PART #: 9154756

2007 AND UP JEEP JK FOG LIGHTS

No Drilling Required | Direct Plug-And-Play With Factory Wiring | Dramatically Increased Visibility

ITEM #	PART #	APPLICATION
XIL-OE0709JKV2OPR	9145754	07-09 Jeep JK Fog Light Upgrade
XIL-OE0709JKV2OPRH	9891811	07-09 Jeep JK Fog Light Upgrade Lights with Halo
XIL-OE1012JKV2OPR	9154756	2010+ Jeep JK Fog Light Upgrade
XIL-OE1012JKV2OPRH	9891828	2010+ Jeep JK Fog Light Upgrade with Halo



ITEM #: XIL-OE13JKXOPRH Shown
PART #: 9892474

JEEP JK X FOG LIGHTS

No Drilling Required | Direct Plug-And-Play With Factory Wiring | Dramatically Increased Visibility

ITEM #	PART #	APPLICATION
XIL-OE13JKXOPR	9891088	2013+ Jeep JK X Fog Light Upgrade
XIL-OE13JKXOPRH	9892474	2013+ Jeep JK X Fog Light Upgrade with Halo

HOOD MOUNT



ITEM #: XIL-OEH0713JKPX36 Shown
PART #: 9891002

HOOD MOUNT KITS FOR JEEP JK

No Drill Installation | Bracket Holds up to 24" Light Bar | Adds Up to 19,008 lm

ITEM #	PART #	APPLICATION
XIL-OEH0713JKPX36	9891002	Bracket with 21" XIL-PX3610 Light Bar For Max Light Output
XIL-OEH0713JKXP112	9891019	Bracket with 24" XPI-12M Light Bar For Long Distance



ACCESSORIES



ITEM #: HIL-STW Shown
PART #: 4005419

TANTRUM 8 POD UNDERCARRIAGE LIGHTING KITS

Add Color to Your Jeep | Includes Wireless Remote | 4 Pods with 10' Cords 4 Pods with 20' Cords

ITEM #	PART #	COLOR
HIL-STA	4005662	Amber
HIL-STB	4005372	Blue
HIL-STG	4005396	Green

ITEM #	PART #	COLOR
HIL-STM	4005679	Multi
HIL-STR	4005389	Red
HIL-STW	4005419	White

See Page 49 for Complete Tantrum Details

SECURITY HARDWARE

Secure Your Lights and Accessories



DURA MINI

2.75" Universal Flood Light



PRO POD

Available in Multiple Colors



View our Website for Complete Range of Accessories

FOG LIGHT UPGRADES



BUMPER LIGHT BARS



A-PILLAR LIGHTS



DRIVING LIGHTS



ROOF LIGHT BARS



ACCESSORIES



FOG LIGHT UPGRADES



ITEM #: XIL-OE9913FSDDURA
PART #: 9891200



ITEM #: XIL-OE0711GSUMX
PART #: 9133157

FORD TRUCKS PLUG AND PLAY LED FOG LIGHT UPGRADE KITS

ITEM #	PART #	APPLICATION
XIL-OE9913FSDDURA	9891200	99-16 Ford Superduty Fog Light Using 2 x DURA-410 Lights
XIL-OE10FROP	9133515	10-14 Ford Raptor Fog Light Using 4 x XIL-OP110 Lights
XIL-OE10FROPH	9892450	10-14 Ford Raptor Fog Light Using 4 x Halo XIL-OPH115 Lights

DODGE/ RAM TRUCKS PLUG AND PLAY LED FOG LIGHT UPGRADE KITS

ITEM #	PART #	APPLICATION
XIL-OE0913DROP	9888552	10-16 Dodge Ram Fog Light Using 2 x XIL-OP110 Lights
XIL-OE0913DROP1MX2	9890685	10-16 Dodge Ram Fog Light Using 4 x Optimus Lights
XIL-OE0210DRUMX	9133065	02-10 Dodge Ram Fog Light Using 2 x XIL-UMX4010 Lights

GM TRUCKS PLUG AND PLAY LED FOG LIGHT UPGRADE KITS

ITEM #	PART #	APPLICATION
XIL-OE0711GSUMX	9133157	07-13 GMC Sierra Fog Light Using 2 x XIL-UMX4010 Lights
XIL-OE0711CSS1100	9120829	07-13 Chevrolet Silverado Fog Light Using 4 x XIL-S1100 Lights

TOYOTA TRUCKS PLUG AND PLAY LED FOG LIGHT UPGRADE KITS

ITEM #	PART #	APPLICATION
XIL-OE0711TTUMX	9133249	07-14 Toyota Tundra Fog Light Using 2 x XIL-UMX4010 Lights

View our website for complete application information

A-PILLAR LIGHTS



ITEM #: CTL-CPZ110KIT Shown
PART #: 9151069

4.5" LED LIGHT CANNON

Multiple Mounting Options | Lightweight Hybrid Housing | Plug and Play Installation

ITEM #	PART #	KIT INCLUDES
CTL-CPZ110KIT	9151069	2 x 4.5" 25-Watt LED Light Cannons and Harness
CTL-CPZ110XPKIT	9893365	2 x 4.5" 40-Watt LED Light Cannons and Harness

See Page 18 for Complete Cannon Details

SNAP-ON COVERS FOR CANNONS CHANGE BEAM AND COLOR

Clear Covers to Protect | Red Covers for Sand | Amber Covers for Fog and Debris



ITEM #	PART #	APPLICATION
PCV-CP1RCB	9893235	Red Combo Beam for 4.5" Cannon
PCV-CP1BL	9157450	Black Protective for 4.5" Cannon

See Page 47 for Complete Polycarbonate Cover Details

ROOF LIGHT BARS



ITEM #: XPR-27M Shown
PART #: 9891682

50" XPR LONG DISTANCE LIGHT BAR WITH TILTED REFLECTORS

Tilted Reflectors for Wide Pattern | Mount Using End Caps Or Feet | Wiring Included

ITEM #	PART #	APPLICATION
XPR-27M	9891682	50" Tilted Reflector XPR Light Bar

See Page 28 for Complete XPR Details

50" XMITTER PRIME XTREME MAX LIGHT OUTPUT LIGHT BAR

Mixed Beam for Wide Pattern | Mount Using End Caps Or Feet | Wiring Included



ITEM #: XIL-PX90M Shown
PART #: 9132792

ITEM #	PART #	FITS
XIL-PX90M	9132792	50" Mixed Beam PX Light Bar

See Page 28 for Complete PX Details

BUMPER LIGHT BARS



ITEM #: XIL-OEB09F150PX36 Shown
PART #: 9891156

FORD TRUCKS PLUG AND PLAY LED FOG LIGHT UPGRADE KITS

ITEM #	PART #	APPLICATION
XIL-OEB09F150PX36	9891156	09-14 Ford F150 Using 1 x XIL-PX3610 Light Bar
XIL-OEB09F150ECO	9891170	09-14 Ford F150 Eco-Boost Using 2 x XIL-PX610 Light Bar
XIL-OEB10FRPX3610	9887357	10-14 Ford Raptor Using 1 x XIL-PX3610 Light Bar
XIL-OEB0810FSDPX3610	9891842	08-10 Ford Superduty Using 1 x XIL-PX3610 Light Bar
XIL-OEB0810FSDXPI12M	9892306	08-10 Ford Superduty Using 1 x XPI-12M Light Bar
XIL-OEB1114FSDPX3610	9891873	11-16 Ford Superduty Using 1 x XIL-PX3610 Light Bar
XIL-OEB1114FSDXPI12M	9892290	11-16 Ford Superduty Using 1 x XPI-12M Light Bar



ITEM #: XIL-OEB0913DRPX3610 Shown
PART #: 9889245

DODGE/RAM TRUCKS PLUG AND PLAY LED FOG LIGHT UPGRADE KITS

ITEM #	PART #	APPLICATION
XIL-OEB0913DRPX3610	9889245	10-16 Dodge Ram Using 1 x XIL-PX3610

View our website for complete application information

DRIVING LIGHTS



ITEM #: CTL-CPZ610KIT Shown
PART #: 9888545

6.7" LED LIGHT CANNON

Multiple Mounting Options | 25 Lights in 1 With Snap on Covers | Wiring Included

ITEM #	PART #	APPLICATION
CTL-CPZ610KIT	9888545	Two 50-Watt Single Source LED Long Distance 6.7" Lights

See Page 18 for Complete Cannon Details



ITEM #: CTL-TPX1810 Shown
PART #: 9111018

6.7" TRANSPORTER 18 LED DRIVING LIGHT

Smooth Beam Pattern to Fill Roadway | Color Changing Covers | Wiring Included

ITEM #	PART #	APPLICATION
CTL-TPX1810	9111018	90 Watt 6.7" Light with 10° Spot Beam Pattern
CTL-TPX1840	9111193	90 Watt 6.7" Light with 40° Flood Beam Pattern

See Page 18 for Complete Transporter Details

ACCESSORIES



ITEM #: XIL-SRECEIVERDURAMX2 Shown
PART #: 9899121

RECEIVER TOW MOUNT KIT FOR REVERSE FLOOD LIGHTS

Wire to Reverse or Separate Switch | Weatherproof Lights For Boat Launching | Multiple Lights Available

ITEM #	PART #	APPLICATION
XIL-SRECEIVERDURAMX2	9899121	Receiver Light Kit with Bracket, 2 x DURA-M460, Harness
XIL-SRECEIVERS1101X2	4008595	Receiver Light Kit with Bracket, 2 x XIL-S1101, Harness

WINCH MOUNT
Light Bar Mount Plate for Winch



FLUSH MOUNT LIGHTS
DURA FLUSH



BORG MODULE
Bluetooth Controller for Prime Drive



View our Website for Complete Range of Accessories

BUMPER LIGHT BARS



BUMPER LIGHTS



LOAD LIGHTS



CAB-OVER



ACCESSORIES



BUMPER LIGHT BARS

XMITTER PRIME XTREME MAXIMUM LIGHT OUTPUT LIGHT BAR

Full Range Fills in Road Way | Multiple Mounting Options | Wiring Included



ITEM #: XIL-PX3610
PART #: 9117041

ITEM #	PART #	APPLICATION
XIL-PX3610	9117041	20" Spot Beam LED Light Bar
XIL-PX5410	9117225	30" Spot Beam LED Light Bar

See Page 22 for Complete PX Details

XPR-S XTREME LONG DISTANCE LIGHT BAR

IRIS Reflector for Long Range Light | Dual Mounting Options Included | Wiring Included



ITEM #: XPR-12S Shown
PART #: 9897394

ITEM #	PART #	INCLUDES
XPR-12S	9897394	24" XPR-S Light Bar Producing 2,461 ft of Usable Light
XPR-15S	9897400	29" XPR-S Light Bar Production 2,784 ft of Usable Light

See Page 27 for Complete XPR-S Details

LOAD LIGHTS



ITEM #: XIL-UMX4060 Shown
PART #: 9118307

UTILITY MARKET SERIES 35-WATT LED WORK LIGHT

Single Stud Mounting | Available in Round or Square Housing | Durable Polycarbonate Lens

ITEM #	PART #	APPLICATION
XIL-UMX4060	9118307	4" Round LED Work Light 60° Flood Beam
XIL-UMX4460	9118482	4" Square LED Work Light 60° Flood Beam

See Page 62 for Complete UMX Details



ITEM #: DURA-660 Shown
PART #: 9888385

DURA SERIES 30 AND 20 WATT LED WORK LIGHTS

Single Stud Mounting | Two Sizes Available | Durable Polycarbonate Lens

ITEM #	PART #	APPLICATION
DURA-460	9141527	4" Square 20-Watt Work Light 60° Flood Beam
DURA-660	9888385	5" Rectangular 30-Watt Work Light 60° Flood Beam

See Page 64 for Complete DURA Details

BUMPER LIGHTS



ITEM #: CTL-CPZ610KIT Shown
PART #: 9888545



ITEM #: CTL-TPX1810 Shown
PART #: 9111018

6.7" LED LIGHT CANNON

Multiple Mounting Options | 25 Lights in 1 With Snap on Covers | Wiring Included

ITEM #	PART #	APPLICATION
CTL-CPZ610KIT	9888545	Two 50-Watt Single Source LED Long Distance 6.7" Lights

See Page 18 for Complete Cannon Details

6.7" TRANSPORTER 18 LED DRIVING LIGHT

Smooth Beam Pattern to Fill Roadway | Color Changing Covers | Wiring Included

ITEM #	PART #	APPLICATION
CTL-TPX1810	9111018	90 Watt 6.7" Light with 10° Spot Beam Pattern
CTL-TPX1840	9111193	90 Watt 6.7" Light with 40° Flood Beam Pattern

See Page 18 for Complete Transporter Details

CAB-OVER



ITEM #: CTL-CPZ810KIT Shown
PART #: 9890074



8.7" LED LIGHT CANNON

Multiple Mounting Options | 25 Lights in 1 With Snap on Covers | Lights Up 3,280 ft of Usable Light

ITEM #	PART #	APPLICATION
CTL-CPZ810KIT	9890074	Two 90-Watt Single Source LED Long Distance 8.7" Lights

See Page 18 for Complete Cannon Details

SNAP-ON COVERS FOR 8.7" CANNONS CHANGE BEAM AND COLOR

Black Street Legal Cover | Amber Covers for Snow | Combo Cover for Best of Both Beams

ITEM #	PART #	APPLICATION
PCV-8500YCB	9893211	8.7" Amber Combo Beam Cover
PCV-8500Y	4002791	8.7" Amber Spot Cover
PCV-8500BL	9890876	8.7" Black Protective Cover

See Page 47 for Complete Polycarbonate Cover Details

ACCESSORIES



ITEM #: XIL-PDW Shown
PART #: 9136127

PRO POD UNDER GLOW LIGHTING

Add Color to Your UTV | Durable PC Lens for Any Application | Add Accent Light Anywhere

ITEM #	PART #	COLOR
XIL-PDA	9136219	Amber
XIL-PDB	9136301	Blue
XIL-PDG	9136394	Green

ITEM #	PART #	COLOR
XIL-PDR	9136486	Red
XIL-PDW	9136127	White

See Page 48 for Complete Pro Pod Details

SECURITY HARDWARE

Secure Your Lights and Accessories



DURA MINI

2.75" Universal Flood Light



UTILITY FLOOD

Available in Multiple Colors



View our Website for Complete Range of Accessories

AUTOMOTIVE ACCESSORIES

POLYCARBONATE LIGHT COVERS

ABOUT POLYCARBONATE LIGHT COVERS

Vision X polycarbonate translucent covers not only protect your light, but they also improve vision in dust, fog, or snow. Another benefit of adding a cover is the capability to change your beam pattern. All covers are made with a UV Protective Coating to prevent fading. Each cover is finished with a glow in the dark printed "X" for a unique look at night when the lights are off.



COVER COLORS



CLEAR

Unbreakable, dust resistant protection to protect the light from debris and particulate. Without changing light color or performance.



BLACKOUT

Covers the fixture with a solid black protective cover with a high contrast "X" logo. Required in select states for on-road use.



AMBER

Battles fog conditions by reducing the amount of blue light. Mimics classic Halogen color temperature. Great for driving in dust at high speeds.



BLUE

Increases lighting distance when used in snow conditions by reflecting the blue light off the snow. Recommended for vehicles in heavy winter conditions.



RED

Reduces light temperature and glare back in order to enhance penetration in dust and air particulate. Ideal for vehicles in extreme dust conditions.

COVER BEAMS



SPOT

Spot covers maintain original lighting beam pattern while protecting the lens from harmful debris.



COMBO

Combo covers combine the distance of a spot cover with the peripheral illumination of a euro cover.



EURO *ELLIPTICAL

Euro covers illuminate peripherals while losing some distance effectiveness.

*Reduces left peripheral illumination for oncoming traffic.



FLOOD *WIDE FLOOD

Wide Flood covers illuminate a wide field of view in exchange for distance effectiveness.

* Flood covers is the vertical beam equivalent to flood covers.

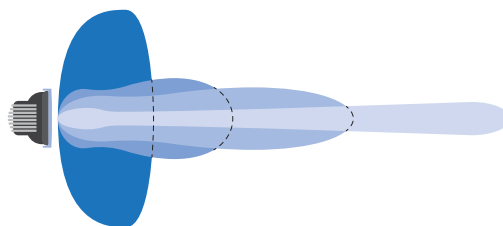

OPTIMUS ROUND & OPTIMUS HALO ROUND

ITEM #	PART #	COLOR	BEAM
PCV-OPR1	9889528	CLEAR	SPOT
PCV-OPR1B	9889559	BLUE	SPOT
PCV-OPR1Y	9889740	AMBER	SPOT
PCV-OPR1R	9889719	RED	SPOT
PCV-OPR1EU	9889535	CLEAR	EURO
PCV-OPR1BEU	9889566	BLUE	EURO
PCV-OPR1YEU	9889757	AMBER	EURO
PCV-OPR1REU	9889726	RED	EURO
PCV-OPR1FL	9889542	CLEAR	FLOOD
PCV-OPR1BFL	9889573	BLUE	FLOOD
PCV-OPR1YFL	9889764	AMBER	FLOOD
PCV-OPR1RFL	9889733	RED	FLOOD
PCV-OPR1WF	9890944	CLEAR	WIDE FLOOD
PCV-OPR1BWF	9890906	BLUE	WIDE FLOOD
PCV-OPR1YWF	9890968	AMBER	WIDE FLOOD
PCV-OPR1RWF	9890937	RED	WIDE FLOOD
PCV-OPR1EL	9890913	CLEAR	ELLIPTICAL
PCV-OPR1BEL	9890890	BLUE	ELLIPTICAL
PCV-OPR1YEL	9890951	AMBER	ELLIPTICAL
PCV-OPR1REL	9890920	RED	ELLIPTICAL
PCV-OPR1BL	9889580	BLACK	PROTECTIVE

* Compatible with all beam patterns

4.5 LED LIGHT CANNON

ITEM #	PART #	COLOR	BEAM
PCV-CP1	9151151	CLEAR	SPOT
PCV-CP1B	9157184	BLUE	SPOT
PCV-CP1Y	9157726	AMBER	SPOT
PCV-CP1R	9162492	RED	SPOT
PCV-CP1CB	9893228	CLEAR	COMBO
PCV-CP1BCB	9893242	BLUE	COMBO
PCV-CP1YCB	9893259	AMBER	COMBO
PCV-CP1RCB	9893235	RED	COMBO
PCV-CP1EU	9151243	CLEAR	EURO
PCV-CP1BEU	9157276	BLUE	EURO
PCV-CP1YEU	9157818	AMBER	EURO
PCV-CP1REU	9157542	RED	EURO
PCV-CP1FL	9151335	CLEAR	FLOOD
PCV-CP1BFL	9157368	BLUE	FLOOD
PCV-CP1YFL	9157900	AMBER	FLOOD
PCV-CP1RFL	9157634	RED	FLOOD
PCV-CP1WF	9890562	CLEAR	WIDE FLOOD
PCV-CP1BWF	9890654	BLUE	WIDE FLOOD
PCV-CP1YWF	9890586	AMBER	WIDE FLOOD
PCV-CP1RWF	9890883	RED	WIDE FLOOD
PCV-CP1EL	9890661	CLEAR	ELLIPTICAL
PCV-CP1BEL	9890647	BLUE	ELLIPTICAL
PCV-CP1YEL	9890579	AMBER	ELLIPTICAL
PCV-CP1REL	9890678	RED	ELLIPTICAL
PCV-CP1BL	9157450	BLACK	PROTECTIVE

6.7 LED LIGHT CANNON

ITEM #	PART #	COLOR	BEAM
PCV-6500	4003248	CLEAR	SPOT
PCV-6500B	4003569	BLUE	SPOT
PCV-6500Y	4002784	AMBER	SPOT
PCV-6500R	4004689	RED	SPOT
PCV-6500CB	9895703	CLEAR	COMBO
PCV-6500BCB	9895710	BLUE	COMBO
PCV-6500YCB	9895734	AMBER	COMBO
PCV-6500RCB	9893198	RED	COMBO
PCV-6500EU	9888453	CLEAR	EURO
PCV-6500BEU	9888460	BLUE	EURO
PCV-6500YEU	9888484	AMBER	EURO
PCV-6500REU	9888477	RED	EURO
PCV-6500FL	9888491	CLEAR	FLOOD
PCV-6500BFL	9888507	BLUE	FLOOD
PCV-6500YFL	9888521	AMBER	FLOOD
PCV-6500RFL	9888514	RED	FLOOD
PCV-6500WF	9888771	CLEAR	WIDE FLOOD
PCV-6500BWF	9889788	BLUE	WIDE FLOOD
PCV-6500YWF	9889801	AMBER	WIDE FLOOD
PCV-6500RWF	9889795	RED	WIDE FLOOD
PCV-6500EL	9890616	CLEAR	ELLIPTICAL
PCV-6500BEL	9890609	BLUE	ELLIPTICAL
PCV-6500YEL	9890630	AMBER	ELLIPTICAL
PCV-6500REL	9890623	RED	ELLIPTICAL
PCV-6500BL	9160245	BLACK	PROTECTIVE

* Also compatible with Transporter and HID-6500

8.7 LED LIGHT CANNON

ITEM #	PART #	COLOR	BEAM
PCV-8500	4003255	CLEAR	SPOT
PCV-8500B	4003583	BLUE	SPOT
PCV-8500Y	4002791	AMBER	SPOT
PCV-8500R	4003576	RED	SPOT
PCV-8500CB	9893182	CLEAR	COMBO
PCV-8500BCB	9893204	BLUE	COMBO
PCV-8500YCB	9893211	AMBER	COMBO
PCV-8500RCB	9893198	RED	COMBO
PCV-8500EU	9890128	CLEAR	EURO
PCV-8500BEU	9890098	BLUE	EURO
PCV-8500YEU	9890470	AMBER	EURO
PCV-8500REU	9890432	RED	EURO
PCV-8500FL	9890135	CLEAR	FLOOD
PCV-8500BFL	9890104	BLUE	FLOOD
PCV-8500YFL	9890487	AMBER	FLOOD
PCV-8500RFL	9890449	RED	FLOOD
PCV-8500WF	9890463	CLEAR	WIDE FLOOD
PCV-8500BWF	9890111	BLUE	WIDE FLOOD
PCV-8500YWF	9890142	AMBER	WIDE FLOOD
PCV-8500RWF	9890456	RED	WIDE FLOOD
PCV-8500EL	9890081	CLEAR	ELLIPTICAL
PCV-8500BEL	9890869	BLUE	ELLIPTICAL
PCV-8500YEL	9890159	AMBER	ELLIPTICAL
PCV-8500REL	9890425	RED	ELLIPTICAL
PCV-8500BL	9890876	BLACK	PROTECTIVE

* Also compatible with HID-8500

LOW PROFILE XTREME

ITEM #	PART #	FITS	COLOR	BEAM
PCV-LP3BL	9155296	XIL-LPX3*	BLACK	PROTECTIVE
PCV-LP6BL	9155388	XIL-LPX6*	BLACK	PROTECTIVE
PCV-LP9BL	9135946	XIL-LPX9*	BLACK	PROTECTIVE
PCV-LP15BL	9155470	XIL-LPX15*	BLACK	PROTECTIVE
PCV-LP18BL	9135762	XIL-LPX18*	BLACK	PROTECTIVE
PCV-LP24BL	9155654	XIL-LPX24*	BLACK	PROTECTIVE
PCV-LP33BL	9155838	XIL-LPX33*	BLACK	PROTECTIVE
PCV-LP36BL	9155920	XIL-LPX36*	BLACK	PROTECTIVE
PCV-LP3Y	9165103	XIL-LPX3*	AMBER	SPOT
PCV-LP6Y	9165196	XIL-LPX6*	AMBER	SPOT
PCV-LP9Y	9136035	XIL-LPX9*	AMBER	SPOT
PCV-LP15Y	9164564	XIL-LPX15*	AMBER	SPOT
PCV-LP18Y	9135854	XIL-LPX18*	AMBER	SPOT
PCV-LP24Y	9164748	XIL-LPX24*	AMBER	SPOT
PCV-LP33Y	9164922	XIL-LPX33*	AMBER	SPOT
PCV-LP36Y	9165011	XIL-LPX36*	AMBER	SPOT

* Compatible with all beam patterns

XMITTER PRIME XTREME

ITEM #	PART #	FITS	COLOR	BEAM
PCV-P6BL	9156019	XIL-PX6*	BLACK	PROTECTIVE
PCV-P12BL	9156101	XIL-PX12*	BLACK	PROTECTIVE
PCV-P18BL	9156194	XIL-PX18*	BLACK	PROTECTIVE
PCV-P30BL	9156378	XIL-PX30*	BLACK	PROTECTIVE
PCV-P36BL	9156460	XIL-PX36*	BLACK	PROTECTIVE
PCV-P54BL	9156736	XIL-PX54*	BLACK	PROTECTIVE
PCV-P72BL	9157009	XIL-PX72*	BLACK	PROTECTIVE
PCV-P90BL	9888064	XIL-PX90*	BLACK	PROTECTIVE
PCV-P6Y	9166186	XIL-PX6*	AMBER	SPOT
PCV-P12Y	9165288	XIL-PX12*	AMBER	SPOT
PCV-P18Y	9165370	XIL-PX18*	AMBER	SPOT
PCV-P30Y	9165554	XIL-PX30*	AMBER	SPOT
PCV-P36Y	9165646	XIL-PX36*	AMBER	SPOT
PCV-P54Y	9165912	XIL-PX54*	AMBER	SPOT
PCV-P72Y	9166278	XIL-PX72*	AMBER	SPOT
PCV-P90Y	9887883	XIL-PX90*	AMBER	SPOT

* Compatible with all beam patterns

AUTOMOTIVE ACCESSORIES

ACCENT LIGHTING

ABOUT ACCENT LIGHTING

Vision X offers a diverse line of accent pod lighting. Easily attract attention to your vehicle with the wide variety of colors. Each durable pod accepts 9-32 volt input and features a strong black housing. Ideal for professional grade applications and weekend enthusiasts alike.



Reinforced Mounting

Vision X Pro Pod LEDs each feature four equally distant mounting holes, allowing the light to be securely fastened to a large variety of surfaces and letting you put the light where it needs to be.

UNIVERSAL PRO PODS

LED POD PERFECT FOR ROCK LIGHTING OR COMPARTMENT LIGHTING
Impact Resistant Lens | Weatherproof Housing for All Conditions | 3' Cord



ITEM #: XIL-PDW Shown
PART #: 9136127

COLORS Amber, Blue, Green, Red, White	WARRANTY Extended	DIMENSIONS 1.76" Diameter
RAW LUMENS 140 lm (ea)	HOUSING Aluminum	METRIC 45mm Diameter

ITEM #	PART #	COLOR
XIL-PDA	9136219	Amber
XIL-PDB	9136301	Blue
XIL-PDG	9136394	Green

ITEM #	PART #	COLOR
XIL-PDR	9136486	Red
XIL-PDW	9136127	White

UNIVERSAL PODS

COLORED LED LIGHTING FOR ANY APPLICATION
Impact Resistant Acrylic Lens | Weatherproof Housing for All Conditions | 10' Cord



ITEM #: HIL-DW Shown
PART #: 4004054

COLORS Amber, Blue, Green, Red, White	WARRANTY Standard	DIMENSIONS 1.25" Diameter
RAW LUMENS 70 lm (ea)	HOUSING Aluminum	METRIC 32mm Diameter

ITEM #	PART #	COLOR
HIL-DA	4004078	Amber
HIL-DB	4004139	Blue
HIL-DG	4004146	Green

ITEM #	PART #	COLOR
HIL-DR	4004061	Red
HIL-DW	4004054	White



TANTRUM



ITEM #: HIL-STB Shown
PART #: 4005372

RUGGED LED STROBE OR ROCK LIGHT KIT
Wireless Remote | Multi-Speed Scanning and Flash Control | 4 Pods with 10' Cords 4 Pods with 20' Cords

COLORS Amber, Blue, Green, Multi, Red, White	WARRANTY Standard	DIMENSIONS 1.25" Diameter
RAW LUMENS 560 lm (kit)	HOUSING Aluminum	METRIC 32mm Diameter



ITEM #	PART #	COLOR
HIL-STA	4005662	Amber
HIL-STB	4005372	Blue
HIL-STG	4005396	Green

ITEM #	PART #	COLOR
HIL-STM	4005679	Multi
HIL-STR	4005389	Red
HIL-STW	4005419	White

STRIP LIGHT



ITEM #: XIL-ST7.5 Shown
PART #: 9167626



ITEM #: XIL-ST12 Shown
PART #: 9141701

TOUCH ACTIVATED OR STANDARD COMMERCIAL DESIGN
Universal Application | Touch Activated Model Available | Compact Design

ACTIVATION MODES Touch On/Off, Hard-wired	WARRANTY Standard	HEIGHT 0.92"/23mm
RAW LUMENS 141-328 lm (ea)	LENGTH 7.4", 11.9"	DEPTH 0.59"/15mm



ITEM #	PART #	MODE	LENGTH	ITEM #	PART #	MODE	LENGTH
XIL-ST7.5	9167626	Touch	7.4"/189 mm	XIL-SL7.5	9167534	Standard	7.4"/189 mm
XIL-ST12	9141701	Touch	11.9"/303 mm	XIL-SL12	9141794	Standard	11.9"/303 mm

LED BAGGER LIGHT KIT



ITEM #: XMC-BKW2 Shown
PART #: 9895246

LOW CONSUMPTION COMPARTMENT LIGHTING FOR TRUNKS, BAGS, SADDLES
Two Light Kit | 40 Inch Power Cord With Flush Switch Included | Water & Dust Proof

BEAM MODES Frosted Lens	WARRANTY Extended	DIMENSIONS 1.76" Diameter
RAW LUMENS 280 lm (kit)	WEIGHT 0.20 lb / 0.09 kg (ea)	METRIC 45mm Diameter



ITEM #	PART #	WIRING	QTY
XMC-BKW2	9895246	40" Cord With Switch	Two White Pods

XMC HEADLIGHT ACCESSORIES



ITEM #: P-HLH14 Shown
PART #: 9895475



ITEM #: XMC-H42H9H11 Shown
PART #: 9892900



ITEM #: XMC-H42DELPHI Shown
PART #: 9892894

6 LED SUBAQUA

UNDERWATER LED MODULE FOR OE TRANSOM INTEGRATION

Transom LED Light | New Model Produces Twice As Much Light | Multiple Colors Available



ITEM #: XIL-U625W Shown
PART #: 9897578

SUBMERSIBLE 100'/30m	WARRANTY Extended	DIMENSIONS 4.13" x 4.13" x 1.25"
RAW LUMENS 1,366 lm (ea)	COLORS Amber, Blue, Green, Red, White	METRIC 105mm x 105mm x 33mm

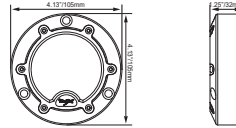
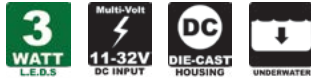

ITEM #	PART #	COLOR	BEAM
XIL-U625A	9897967	Amber	25°
XIL-U625B	9897554	Blue	25°
XIL-U625G	9897561	Green	25°
XIL-U625R	9897585	Red	25°
XIL-U625W	9897578	White	25°



PRIME DIMMER

PUSH BUTTON OR DIAL DIMMER FOR PRIME LIGHTS

Push Button Dimmer | Designed for Prime Drive Lights | Dial Knob Dimmer



ITEM #: XIL-PDIMMERB Shown
PART #: 4009264

ITEM #	PART #	CONTROL	DIMMER RANGE	CORD LENGTH
XIL-PDIMMER	4009257	Dial Knob	50%-100%	5.50"/139.7mm
XIL-PDIMMERB	4009264	Button Knob	50% & 100%	5.50"/139.7mm

BATTERY PACKS

RECHARGEABLE POWER SOURCE FOR VISION X LIGHTS

Long Life Battery | Compatible with 12V Lights | Compact & Lightweight



ITEM #: XPC-B30 Shown
PART #: 9130095

ITEM #	PART #	MAX LOAD	CAPACITY	SOLO RUN TIME	WEIGHT
XPC-B22	4009080	5A	2.2Ah	3 Hours	1.15 lb
XPC-B30	9130095	5A	3.1Ah	5 Hours	1.15 lb
XPC-B65	4009097	8A	6.5Ah	6 Hours	1.00 lb
XPC-B86	4000339	10A	8.6Ah	13 Hours	2.00 lb

UNIVERSAL HARNESSES

UNIVERSAL WIRING HARNESS

30A 12V Relay Included | Lighted Rocker Switch | Weatherproof Deutsch Connectors



ITEM #: P-HARNESS.2XIL Shown
PART #: 4006201

ITEM #	PART #	CONNECTORS	APPLICATION
P-HARNESS.2XIL	4006201	Terminals	2 Light Harness
P-HARNESS.XIL	4006195	Terminals	1 Light Harness
P-HARNESS.HO	9888354	Terminals	High Amp 1 Light Harness
P-DY2M1F	4006263	Deutsch DT Series	Y Adapter
P-UCA	4006218	Cigarette Adapter	Cigarette Power Cord

AUTOMOTIVE ACCESSORIES MOUNTING SOLUTIONS

Vision X offers a variety of mounts and adapters to help you put light in more places. Each adapter allows you to add lights to spots that are normally out-of-bounds with these simple mounting solutions. Series includes extra mounting options for light bars.



LICENSE PLATE MOUNT



ITEM #: XIL-LICENSEPLPX910 Shown
PART #: 9887012

LICENSE PLATE MOUNT

Holds Any LED Bar Up To 20" | Easily Installs Behind License Plate | Powder Coated

ITEM #	PART #	INCLUDED
XIL-LICENSEP	4000308	Bracket
XIL-LICENSEPLPX910	9887012	Bracket, XIL-LPX910 LED Bar & Harness

TOW HITCH MOUNT



ITEM #: XIL-SRECEIVERS1101X2 Shown
PART #: 4008595

TOW HITCH MOUNT

Machined 6061 Aluminum | 2 Bolt Mount for Hitches | Use With Solo Pods Or Dura Mini

ITEM #	PART #	INCLUDED
XIL-SRECEIVER	4000322	Bracket
XIL-SRECEIVERDURAMX2	9899121	Bracket, 2 x DURA-M460
XIL-SRECEIVERS1101X2	4008595	Bracket, 2 x XIL-S1101

[View Website for Application Details](#)



SOLO FLUSH MOUNT

4" FLUSH MOUNT FOR SOLSTICE SOLO POD

Install Flush Into A 2.75" Hole | Ideal for Ceiling Mounts | Black Anodized Finish



ITEM #: XIL-SFLUSHV2 Shown
PART #: 9887777

ITEM #	PART #	DIAMETER	APPLICATION
XIL-SFLUSH	4000315	3.68"/93.47 mm	Front Mount
XIL-SFLUSHV2	9887777	3.68"/93.47 mm	Light Mount
XIL-SFLUSH4	4008243	4.00"/101.6 mm	Front Mount

MAGNETIC BASE

UNIVERSAL TEMPORARY LIGHT MOUNT

Secure Light Temporarily | Multiple to Support Large Lights | Protective Rubber Boot



ITEM #: P-UMB Shown
PART #: 4006225
Lights Not Included

ITEM #	PART #	PULL	INCLUDED
P-UMB.95	4009127	95 lb/43.09 kg	Magnet & Sleeve
P-UMB.65	4009110	65 lb/29.48 kg	Magnet & Sleeve
P-UMB	4006225	75 lb/34.02 kg	Magnet & Rubber Boot

DURA FLUSH MOUNTS

FLUSH MOUNT FOR DURA SERIES

Install Flush | Ideal for Bumpers | Black Powdercoat Finish



ITEM #: DURA-460FLUSH Shown
PART #: 9892993

ITEM #	PART #	INCLUDES
DURA-M460FLUSH	9899138	Bracket, DURA Mini Flush Light
DURA-460FLUSH	9892993	Bracket, DURA 4 LED Flush Light
DURA-660FLUSH	9893006	Bracket, DURA 6 LED Flush Light

END CAP MOUNTS

END CAP MOUNTS FOR LIGHT BARS

M10x1.5 20mm Thread | Sold In Pairs | Ideal For Roof Mounting



ITEM #: XIL-PECM Shown
PART #: 9889191

ITEM #	PART #	DESIGNED FOR
XIL-LPECM	9888811	Xmitter Low Profile
XIL-PECM	9889191	Xmitter Prime
XPI-EM	9892917	XPR & XPI
XIL-ECM	9888781	Xmitter

OPTIMUS HANDLE

OPTIMUS HANDLE FOR PORTABLE APPLICATIONS

Sure-Grip form | Convenient Handle for use with Optimus Series | Portable Application



ITEM #: XIL-OP2HANDLE Shown
PART #: 9887098

ITEM #	PART #	FITS	COLOR
XIL-OP1HANDLE	9890173	Optimus Single & Optimus Round	Black
XIL-OP2HANDLE	9887098	Optimus Dual	Black

XIL-UM HANDLE

UTILITY MARKET LIGHT ACCESSORY FOR ADDITIONAL APPLICATIONS

Sure-Grip form | Convenient Handle for use with UM Series | Portable Application



ITEM #: P-UM40HANDLE Shown
PART #: 9144498

ITEM #	PART #	FITS
P-UM40HANDLE	9888361	UM40xx & UMX40xx
P-UMHANDLE	9887111	UM44xx & UMX44xx

SOLO MOUNTS

SOLO MOUNTS

Combine with Vision X Battery Packs | Portable On-The-Go Lighting | Extends Applications



Various Solo Mounts Shown

ITEM #	PART #	USE
XIL-SHANDLE	4002685	Pistol Grip Handle
XIL-SHELMET	4002753	Helmets
XIL-SHANDLEBAR	4002746	Handlebars
XIL-SCLAMP	9117942	Tube Mounting 0.75"-1.25"
XIL-SCOMBO	4002739	Helmets + Handlebars

MINI SOLO MOUNTS

MINI SOLO MOUNTS

Combine with Vision X Battery Packs | Portable On-The-Go Lighting | Extends Applications



Various Mini Solo Mounts Shown

ITEM #	PART #	USE
XIL-MXHANDLEBAR	9145570	Handlebars
XIL-MXHELMET	9145488	Helmets
XIL-MXCOMBO	9145396	Helmets + Handlebars
XIL-MXCLAMP	9119205	Tube Mounting 0.75"-1.25"

TUBE CLAMP MOUNTS

360° TUBE FRAME MOUNT SYSTEM FOR LIGHTS, LIGHT BARS, AND MORE
Includes All Rubber Gasket and Hardware | Anodized Aluminum | Sold in Pairs



ITEM #: XIL-C175 Shown
PART #: 9897240

ITEM #	PART #	DIAMETER
XIL-C075	9897325	0.75"/19mm
XIL-C100	9897301	1.00"/25mm
XIL-C125	9897288	1.25"/32mm
XIL-C150	9897264	1.50"/38mm
XIL-C175	9897240	1.75"/45mm
XIL-C200	9893372	2.00"/50mm
XIL-C225	9893389	2.25"/57mm
XIL-C250	9893396	2.50"/64mm
XIL-C300	9893402	3.00"/76mm

SECURITY BOLTS

SECURITY HARDWARE REDUCES THEFT BY REQUIRING SPECIAL TOOL TO REMOVE
Fit Virtually Any Bolt | 304 Stainless Steel Construction | Sold as 2 Bolts with 1 Tool



ITEM #: XIL-SB0820 Shown
PART #: 9893426

ITEM #	PART #	SIZE	POPULAR APPLICATIONS
XIL-SB0615	9893440	M6 X 15	L Bracket Mounting Bolt to Side of Light for XPR – XPI Light Bars
XIL-SB0620	9893457	M6 X 20	Bracket to Light bolts Horizon Series
XIL-SB0815	9893419	M8 X 15	Bracket to Light bolts for Optimus Series, DURA Series
XIL-SB0820	9893426	M8 X 20	Bracket to Light on PitMaster Series
XIL-SB0825	9893433	M8 X 25	Any M8 x 25 Bolt

SECURITY NUTS

SECURITY HARDWARE REDUCES THEFT BY REQUIRING SPECIAL TOOL TO REMOVE
Fit Virtually Any Nut | Carbon Steel Construction | Sold as 2 Nuts with 1 Tool



ITEM #: XIL-SN08 Shown
PART #: 9893488

ITEM #	PART #	SIZE	POPULAR APPLICATIONS
XIL-SN06	9897349	M6	Fits to mounting bolts for UF32 – Solo Pods (SP100 - S1100 - MX Solo) - Dura Mini – Light Bar Mounting Feet (Xmitter, PX, LPX, XPI, XPR Series)
XIL-SN08	9893488	M8	Fits to mounting bolts for All Optimus, Dura Series. Fits to bracket to light bolts for 4.7" Cannon and UMX Series
XIL-SN10	9893471	M10	Fits to mounting bolts for 8.7" - 6.7" - 4.7" Cannon Series - Dual Optimus - TPX Series – UMX Series
XIL-SN12	9893464	M12	Any M12 Mounting Hardware

HEAVY / MEDIUM DUTY LIGHTING

RIPPER SERIES

ABOUT THE RIPPER

DESIGNED SPECIFICALLY FOR TRACKED DOZERS, WILL LAST IN ANY APPLICATION.

Built to last. The Ripper Series from Vision X is the hardest working LED fixture you'll find on the market. Rated at 60Grms, the Ripper is capable of standing up to intense amounts of vibration and still perform like it is its first day on the job.

The Ripper is a direct replacement for HID and Halogen fixtures on heavy vibration commercial and industrial machinery. It features Prime Drive ETM (Electronic Thermal Management) that controls the LED temperature to ensure a prolonged LED lifespan. Additionally, the unique vertical and horizontal channeled heat sink increases heat dissipation and further prolongs the lifespan of the light.

FOR USE WITH

**HARSH ENVIRONMENT STRUCTURAL
RUBBER TIRE & TRACK DOZERS
STANCHION LIGHT POLES
WORKOVER DRILL RIGS
HYDRAULIC SHOVELS
WASH BAYS**

RIPPER SERIES MOUNTING



DUAL MOUNTING

Each Ripper comes packaged with a fully-adjustable Trunnion mount with isolated rubber shock absorbers. Combined with the standard Suspension mount, the Ripper can operate in intense vibration applications.

VARIETY OF OPTICS



BEAM PATTERNS

The Ripper 12 and 20 LED lights are available in a large variety of beam patterns, each excelling in specific applications. Currently, 10°, 25°, 40°, 60°, and 90° beam patterns are available.



RIPPER 20 LED

60 Grms RATED FOR HIGH VIBRATION 100-WATT WORK LIGHT
Dual Mounting System | High Vibration Light | OE Upgrade



ITEM #: MIL-RXP2060T Shown
PART #: 9114439

BEAM PATTERNS 10°, 25°, 40°, 60°, 90°, 30°x65°	WARRANTY Extended	DIMENSIONS 6.61" x 6.97" x 4.05"
RAW LUMENS 10,560 lm (ea)	EFFECTIVE LUMENS 7,400 lm (ea)	METRIC 168mm x 1177mm x 103mm
WATTAGE / AMPS 100W / 8.34A @12V	VIBRATION RATING 60 Grms	WEIGHT 7.50 lb / 3.4 kg



ITEM #	PART #	QTY	BEAM	ITEM #	PART #	QTY	BEAM
MIL-RXP2010T	9114163	1	10°	MIL-RXP2060T	9114439	1	60°
MIL-RXP2040T	9114347	1	40°	MIL-RXP2090T	9138640	1	90°

BEAM PATTERN

MIL-RXP2060T | 9114439 - 60° Beam

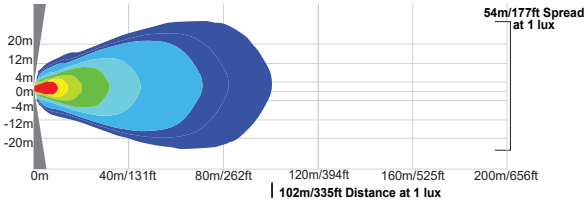

2D VIEW

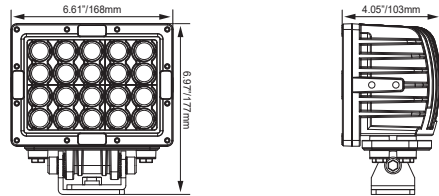

RIPPER 12 LED

60 Grms RATED FOR HIGH VIBRATION 60-WATT WORK LIGHT
Dual Mounting System | High Vibration Light | OE Upgrade



ITEM #: MIL-RXP1260T Shown
PART #: 4009998

BEAM PATTERNS 10°, 25°, 40°, 60°, 90°, 30°x65°	WARRANTY Extended	DIMENSIONS 4.72" x 6.93" x 4.05"
RAW LUMENS 6,336 lm (ea)	EFFECTIVE LUMENS 4,440 lm (ea)	METRIC 120mm x 6.93mm x 103mm
WATTAGE / AMPS 60W / 5.0A @12V	VIBRATION RATING 60 Grms	WEIGHT 5.51 lb / 2.5 kg



ITEM #	PART #	QTY	BEAM	ITEM #	PART #	QTY	BEAM
MIL-RXP1210T	4009974	1	10°	MIL-RXP1260T	4009998	1	60°
MIL-RXP1240T	4009981	1	40°	MIL-RXP1290T	9138558	1	90°

BEAM PATTERN

MIL-RXP1260T | 4009998 - 60° Beam

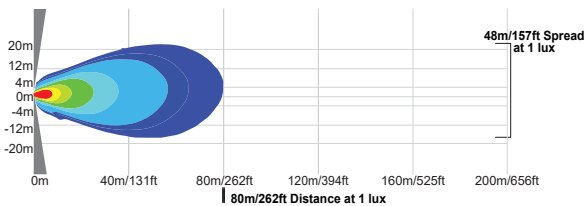

2D VIEW

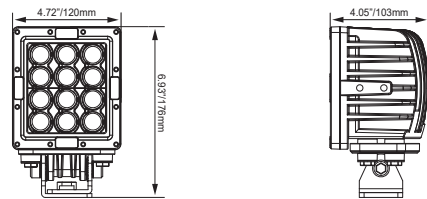

HEAVY / MEDIUM DUTY LIGHTING

SOLSTICE PRIME SERIES

ABOUT THE SOLSTICE PRIME

DESIGNED FOR HEAVY DUTY FLEETS, OE FITMENT DESIGN

The Solstice Prime Series from Vision X combines traditional form factor and single-bolt mounting with the energy-efficient benefits of LED for the ultimate OE upgrade option for commercial and industrial vehicles that use HID and Halogen fixtures.

The Solstice Prime Series is available in 5 LED or 7 LED models, and each feature Prime Drive ETM (Electronic Thermal Management) that controls the LED temperature to ensure a prolonged LED lifespan. Additionally, the unique vertical channeled heat sink increases heat dissipation and further prolongs the lifespan.

FOR USE WITH

UNDERGROUND HAUL TRUCKS
 OPEN PIT HAUL TRUCKS
 MISC WHITE IRON
 WATER TRUCKS
 EXCAVATORS
 GRADERS
 LOADERS
 MUCKER

SOLSTICE PRIME MOUNTING



TRUNNION BRACKET

The Vision X Solstice Prime comes equipped with a full-adjustable 105° Trunnion Bracket that can be easily tuned with a 5mm allen wrench for the optical angle for the most direct and efficient light. Additionally, each bolt on the bracket uses isolated rubber shock absorbers to minimize vibration.

ETM & REDUNDANT CIRCUITRY

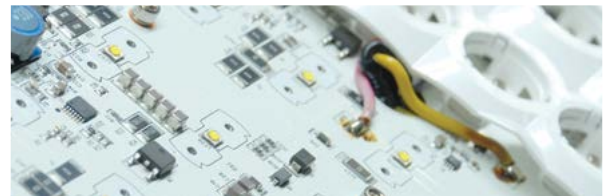

ETM & PRIME DRIVE

Integrated Electronic Thermal Management helps prolong the life of the LEDs by regulating heat levels. Redundant circuit design allows partial light operation until preventative maintenance.



SOLSTICE PRIME 7 LED



ITEM #: XIL-SP740 Shown
PART #: 4009875

OE UPGRADE FOR HEAVY DUTY COMMERCIAL & INDUSTRIAL APPLICATIONS
105° Adjustable Trunnion Bracket | PMW Integrated Dimming | Vertical Fins Maximize Heat Dissipation

BEAM PATTERNS 20°, 40°	WARRANTY Extended	DIMENSIONS 7.17" x 6.89" x 3.17"
RAW LUMENS 7,364 lm (ea)	EFFECTIVE LUMENS 5,155 lm (ea)	METRIC 182mm x 175mm x 81mm
WATTAGE / AMPS 70W / 5.84A @12V	VIBRATION RATING 15.6 Grms	WEIGHT 4.52 lb / 2.05 kg



ITEM #	PART #	QTY	BEAM	ITEM #	PART #	QTY	BEAM
XIL-SP720	4009868	1	20°	XIL-SP740	4009875	1	40°

BEAM PATTERN

XIL-SP740 | 4009875 - 40° Beam

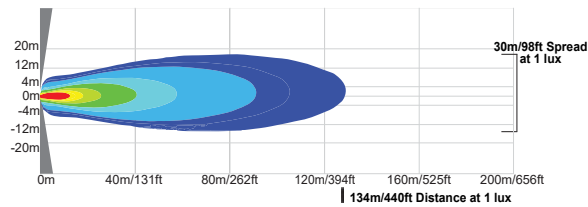

2D VIEW

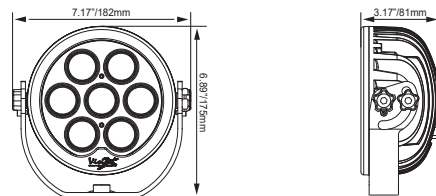

SOLSTICE PRIME 5 LED



ITEM #: XIL-SP540 Shown
PART #: 4009851

OE UPGRADE FOR HEAVY DUTY COMMERCIAL & INDUSTRIAL APPLICATIONS
105° Adjustable Trunnion Bracket | PMW Integrated Dimming | Vertical Fins Maximize Heat Dissipation

BEAM PATTERNS 20°, 40°	WARRANTY Extended	DIMENSIONS 5.83" x 4.92" x 3.11"
RAW LUMENS 5,260 lm (ea)	EFFECTIVE LUMENS 3,682 lm (ea)	METRIC 148mm x 125mm x 79mm
WATTAGE / AMPS 50W / 4.17A @12V	VIBRATION RATING 15.6 Grms	WEIGHT 3.09 lb / 1.4 kg



ITEM #	PART #	QTY	BEAM	ITEM #	PART #	QTY	BEAM
XIL-SP520	4009844	1	20°	XIL-SP540	4009851	1	40°

BEAM PATTERN

XIL-SP540 | 4009851 - 40° Beam

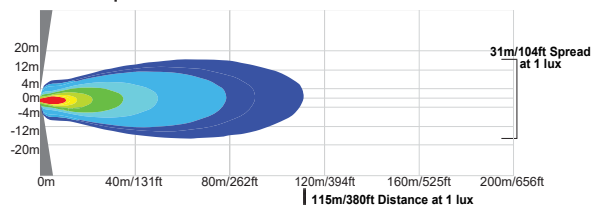

2D VIEW

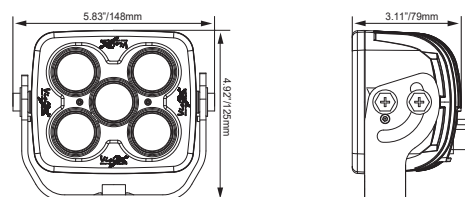

HEAVY / MEDIUM DUTY LIGHTING

SHOCKWAVE SERIES

ABOUT THE SHOCKWAVE

REPLACES FLUORESCENT FIXTURES IN HARSH ENVIRONMENTS

The Vision X Shockwave excels at being a durable fluorescent upgrade for flat mount applications. The Shockwave was designed to replace fluorescent tubes in heavy commercial and industrial work environments.

Each Shockwave has the option of using a Frosted lens that diffuse the light to help reduce shadow areas. Additionally, multiple mounting options are available, including a Flush, and standard brackets.

Fluorescent tubes often break and need replacement. With the Shockwave Series, you can save on unscheduled maintenance with 50,000 hours of LED life for a brighter, longer-lasting light.

SHOCKWAVE SINGLE



SHOCKWAVE SINGLE SERIES

The single panel LED Shockwave produces a 120° beam spread, rugged industrial design, and universal mounting options.

FLUORESCENT REPLACEMENT



FOR HARSH CONDITION MACHINERY

We designed the Shockwave Series to replace ineffective fluorescent fixtures on heavy duty machinery. With the Shockwave, you get more output for much less power.

SHOCKWAVE DUAL



SHOCKWAVE DUAL SERIES

The Dual Shockwave off axis panels produces a 150° beam spread with Integrated Electronic Thermal Management (ETM) and low power consumption.



DC CUBE SHOCKWAVE



ITEM #: MIL-CSWD1296 (top) & MIL-CSWS2496 Shown
PART #: 9898995 & 9899046

PREMIUM FLUORESCENT REPLACEMENT WITH 210° FULL-SPREAD BEAM PATTERN
High Efficacy CUBE LEDs | Power Supply Packages Available | Clear Bezel For Wider Dispersion

BEAM PATTERNS 180°, 210°	WARRANTY Extended	DIMENSIONS 12" 24" 36" 48"
TESTED LUMENS Up to 43,392 lm	INPUT VOLTAGE 9-32V DC	METRIC 304mm 608mm 912mm 1216mm
WATTAGE / AMPS Up to 384W / 32A @12V DC	VIBRATION RATING 15.6 Grms	WEIGHT Varies by Model



2D VIEW

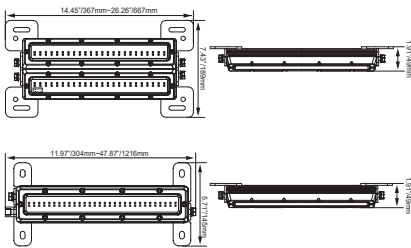

ITEM #	PART #	LENGTH	LEDS	RAW LUMENS	WATTS	AMP DRAW	WEIGHT
MIL-CSWS1248	9899039	Single 12"	48	5,424 LM	48	4A	3.1 LB
MIL-CSWS2496	9899046	Single 24"	96	10,848 LM	96	8A	6.2 LB
MIL-CSWS36144	9899053	Single 36"	144	16,272 LM	144	12A	9.2 LB
MIL-CSWS48192	9899060	Single 48"	192	21,696 LM	192	16A	12.2 LB

ITEM #	PART #	LENGTH	LENS	RAW LUMENS	WATTS	AMP DRAW	WEIGHT
MIL-CSWD1296	9898995	Dual 12"	Clear	10,848 lm	96	8A	5.80 LB
MIL-CSWD24192	9899008	Dual 24"	Clear	21,696 lm	192	16A	11.60 LB
MIL-CSWD36288	9899015	Dual 36"	Clear	32,544 LM	288	24A	17.00 LB
MIL-CSWD48384	9899022	Dual 48"	Clear	43,392 LM	384	32A	22.60 LB

DC SHOCKWAVE



ITEM #: MIL-SWD2440 (Top) & MIL-SWS1210 Shown
PART #: 9126043 & 9150611

MODULAR LED UPGRADE FOR FLUORESCENT LIGHTS
Power Supply & Mounts Available | Frosted or Clear Lens | Direct Fluorescent Replacement

BEAM PATTERNS Ultra Wide 120°, 150°	WARRANTY Extended	DIMENSIONS 12" 24" 36" 48"
RAW LUMENS Up to 7,000 lm	EFFECTIVE LUMENS Up to 4,900 lm	METRIC 304mm 608mm 912mm 1216mm
WATTAGE / AMPS 10-80W / 0.83-6.67A @12V	VIBRATION RATING 15.6 Grms	WEIGHT 3.1 - 22.6 lbs



2D VIEW

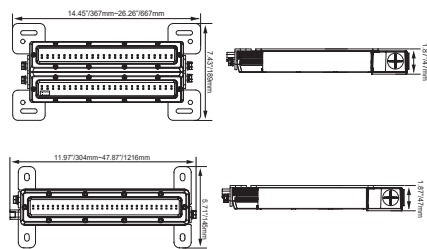

ITEM #	PART #	LENGTH	LENS	RAW LUMENS	WATTS	AMP DRAW	WEIGHT
MIL-SWD1220	9125954	Dual 12"	Clear	1,750 lm	20	1.67A	5.8 lb
MIL-SWD2440	9126043	Dual 24"	Clear	3,500 lm	40	3.34A	11.6 lb
MIL-SWD3660	9126135	Dual 36"	Clear	5,250 lm	60	5.0A	17.0 lb
MIL-SWD4880	9126227	Dual 48"	Clear	7,000 lm	80	6.67A	22.6 lb

ITEM #	PART #	LENGTH	LENS	RAW LUMENS	WATTS	AMP DRAW	WEIGHT
MIL-SWS1210	9125596	Single 12"	Clear	875 lm	10	0.83A	3.1 lb
MIL-SWS2420	9125688	Single 24"	Clear	1,750 lm	20	1.67A	6.2 lb
MIL-SWS3630	9125770	Single 36"	Clear	2,625 lm	30	2.50A	9.2 lb
MIL-SWS4840	9125862	Single 48"	Clear	3,500 lm	40	3.34A	12.2 lb

HEAVY / MEDIUM DUTY LIGHTING

UTILITY MARKET XTREME

ABOUT THE UMX SERIES

OEM/AFTERMARKET REPLACEMENT LIGHTING FOR HALOGEN/HID

The UMX Series excels in a multitude of applications and is a premium OE upgrade for commercial and industrial applications. Both the UMX Round and the UMX Square are capable of delivering greatly increased output and a smoother beam pattern than comparable halogen fixtures.

The UMX is used everywhere from large-scale mining sites to commercial fog light applications that take advantage of the available 10° beam pattern.

Over 528 raw lumens come out of each LED inside the UMX, making it a leader in the 5-Watt LED field.

FOR USE WITH

AGRICULTURAL EQUIPMENT
AIRPORT EQUIPMENT
GARBAGE TRUCKS
FLEET VEHICLES
SERVICE BODIES
EXCAVATORS
SWEEPERS
WRECKERS

REDUCED ENERGY CONSUMPTION



3-WATT MODEL AVAILABLE

For those looking for less power draw, the less powerful UMX Series is available in the same housings as the UMX. The UMX Series utilizes 3-watt LEDs to draw only 21 watts.

FACTORY REPLACEMENT FIXTURE



REPLACES OEM HALOGEN & HID

The UMX Series features a single stud mount allowing it to replace OEM fixtures with ease, including integrated Deutsch plug mated to factory wiring on most equipment manufacturers.



ROUND UTILITY MARKET XTREME



ITEM #: XIL-UMX4060 Shown
PART #: 9118307

XTREME LIGHT OUTPUT OE UPGRADE FOR COMMERCIAL & INDUSTRIAL
Die-Cast Aluminum Housing | Reduced Energy Consumption | 3-Watt Model Available

BEAM PATTERNS 10°, 25°, 40°, 60°, 90°, 30°x65°	WARRANTY Extended	DIMENSIONS 4.49" x 5.47" x 2.99"
RAW LUMENS 3,696 lm (ea)	EFFECTIVE LUMENS 2,590 lm (ea)	METRIC 114mm x 139mm x 76mm
WATTAGE / AMPS 35W / 2.9A @12V	VIBRATION RATING 8.6 Grms	WEIGHT 2.43 lb / 1.1 kg



ITEM #	PART #	QTY	BEAM
XIL-UMX4010	4004719	1	10°
XIL-UMX4040	9118215	1	40°
XIL-UMX4060	9118307	1	60°

BEAM PATTERN

XIL-UMX4060 | 9118307 - 60° Beam

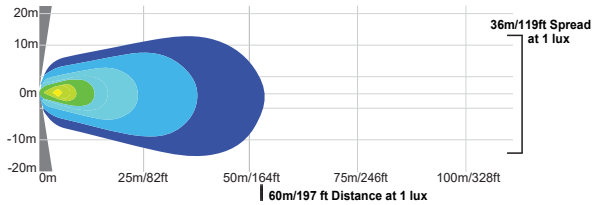

2D VIEW

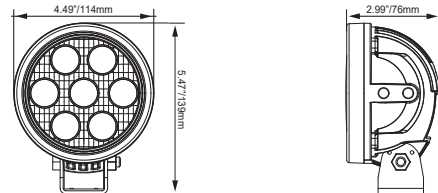

SQUARE UTILITY MARKET XTREME



ITEM #: XIL-UMX4460 Shown
PART #: 9118482

XTREME LIGHT OUTPUT OE UPGRADE FOR COMMERCIAL & INDUSTRIAL
Die-Cast Aluminum Housing | Reduced Energy Consumption | 3-Watt Model Available

BEAM PATTERNS 10°, 25°, 40°, 60°, 90°, 30°x65°	WARRANTY Extended	DIMENSIONS 4.72" x 6.22" x 3.12"
RAW LUMENS 3,696 lm (ea)	EFFECTIVE LUMENS 2,590 lm (ea)	METRIC 120mm x 158mm x 79mm
WATTAGE / AMPS 35W / 2.9A @12V	VIBRATION RATING 8.6 Grms	WEIGHT 2.63 lb / 1.2 kg



ITEM #	PART #	QTY	BEAM
XIL-UMX4410	4004726	1	10°
XIL-UMX4440	9118390	1	40°
XIL-UMX4460	9118482	1	60°

BEAM PATTERN

XIL-UMX4460 | 9118482 - 60° Beam

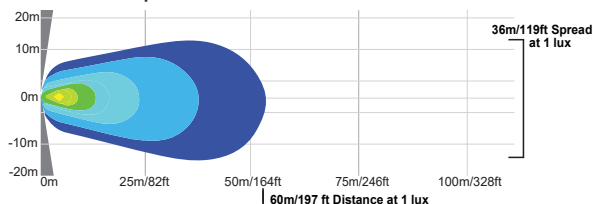

2D VIEW

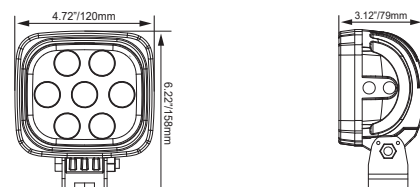

HEAVY / MEDIUM DUTY LIGHTING

DURALUX SERIES

DURA M460



ITEM #: DURA-M460 Shown
PART #: 9895499

ULTIMATE COMPACT FIXTURE FOR UNIVERSAL APPLICATIONS
IP-69K Waterproof/High Pressure Spray | Extended Warranty

BEAM PATTERNS 60°	WARRANTY Extended	DIMENSIONS 2.75" x 3.62" x 1.94"
RAW LUMENS 2,000 lm (ea)	EFFECTIVE LUMENS 950 lm (ea)	METRIC 70mm x 92mm x 49mm
WATTAGE 12W / 1.0A	VIBRATION RATING 8.6 Grms	WEIGHT 0.88 lb / 0.40 kg



ITEM #	PART #	QTY	BEAM
DURA-M460	9895499	1	60°

BEAM PATTERN

DURA-M460 | 9895499 - 60° Beam



2D VIEW

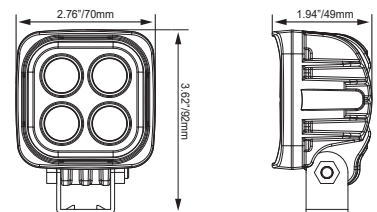

DURA MINI M4M



ITEM #: DURA-M4M Shown
PART #: 9911649

A POWERFUL ANSWER TO A SMALL DRIVING / FOG LIGHT
IP-69K Waterproof/High Pressure Spray | Extended Warranty

BEAM PATTERNS 10 / 25°	WARRANTY Extended	DIMENSIONS 2.75" x 3.62" x 1.94"
RAW LUMENS 2,115 lm (ea)	EFFECTIVE LUMENS 1,480 lm (ea)	METRIC 70mm x 92mm x 49mm
WATTAGE 20W / 1.66A	VIBRATION RATING 8.6 Grms	WEIGHT 0.88 lb / 0.40 kg



ITEM #	PART #	QTY	BEAM
DURA-M4M	9911649	1	10 / 25°
DURA-M4MKIT	9911656	2	10 / 25°

BEAM PATTERN

DURA-M4M | 9911649 - 10/25° Beam

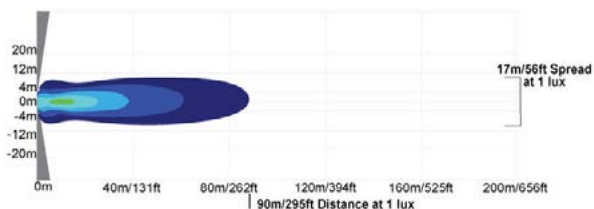

2D VIEW

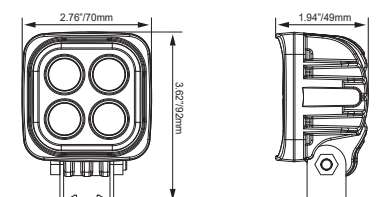

DURALUX 6 LED



ITEM #: DURA-660 Shown
PART #: 9888385

30-WATT HIGH PERFORMANCE UNIVERSAL LED LIGHT
Minimal Amperage Draw | 150-Watt Halogen Comparable Fixture | Durable Die-Cast Housing

BEAM PATTERNS 10°, 40°, 60°	WARRANTY Extended	DIMENSIONS 5.38" x 4.19" x 2.72"
RAW LUMENS 3,168 lm (ea)	EFFECTIVE LUMENS 2,218 lm (ea)	METRIC 139mm x 107mm x 69mm
WATTAGE / AMPS 30W / 2.5A @12V	VIBRATION RATING 8.6 Grms	WEIGHT 2.63 lb / 1.2 kg



ITEM #	PART #	QTY	BEAM
DURA-610	9891125	1	10°
DURA-610KIT	9891309	2	10°

ITEM #	PART #	QTY	BEAM
DURA-640	9888378	1	40°
DURA-660	9888385	1	60°

BEAM PATTERN

DURA-610 | 9891125 - 10° Beam

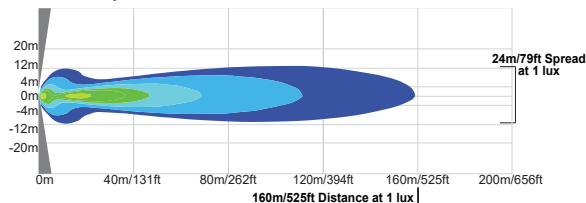

2D VIEW

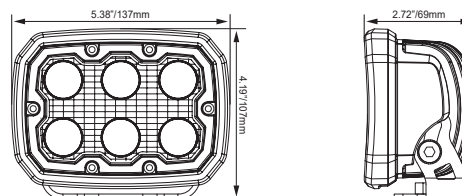

DURALUX 4 LED



ITEM #: DURA-460 Shown
PART #: 9141527

20-WATT HIGH PERFORMANCE UNIVERSAL LED LIGHT
Minimal Amperage Draw | 100-Watt Halogen Comparable Fixture | Durable Die-Cast Housing

BEAM PATTERNS 10°, 40°, 60°, 90°, Amber	WARRANTY Extended	DIMENSIONS 3.94" x 4.24" x 2.57"
RAW LUMENS 2,112 lm (ea)	EFFECTIVE LUMENS 1,480 lm (ea)	METRIC 100mm x 107mm x 65mm
WATTAGE / AMPS 20W / 1.6A @12V	VIBRATION RATING 8.6 Grms	WEIGHT 1.50 lb / 0.68 kg



ITEM #	PART #	QTY	BEAM
DURA-410	9891132	1	10°
DURA-410KIT	9891187	2	10°

ITEM #	PART #	QTY	BEAM
DURA-440	9141619	1	40°
DURA-460	9141527	1	60°
DURA-460A		1	Amber

BEAM PATTERN

DURA-410 | 9891132 - 10° Beam

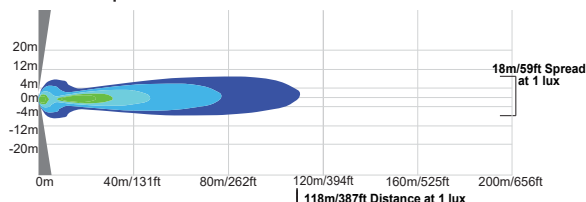

2D VIEW

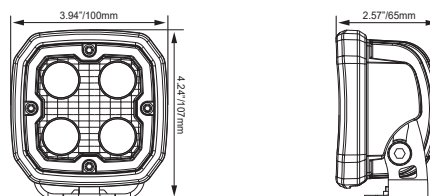



HEAVY EQUIPMENT / MACHINE ACCESSORIES

CONSTRUCTION / ROADWORK AREA LIGHT

POLE-MOUNTED PORTABLE LED LIGHT SOLUTION

Includes 5' to 9' Extendable Pole | Flexible Ball Joints | Folds into Included Storage Case



ITEM #: PVR2CSWD96AC Shown
PART #: 9898384

BEAM PATTERN 210°	WARRANTY Extended	LIGHT DIMENSIONS 11.81" x 4.65" x 1.89"
TESTED LUMENS 21,696 lm	INPUT VOLTAGE 110-277V AC	LIGHT METRIC 300mm x 118mm x 48mm
WATTAGE / AMPS @110V AC 192W / 1.74A	VIBRATION RATING 15.6 Grms	MAXIMUM POLE EXTENSION 9' / 2.4m



ITEM #	PART #
PVR2CSWD96AC	9898384



UTILITY FLOOD



ITEM #: XIL-UF32 Shown
PART #: 4001824

LIGHTWEIGHT UTILITY LED LIGHT WITH 120° FLOOD PATTERN

0.5A Amp Draw At 12V | Available In White, Amber, Blue, Green, Red | Universal Applications

BEAM PATTERNS 120°	WARRANTY Extended	DIMENSIONS 3.4" x 1.9" x 0.9"
RAW LUMENS 500 lm (ea)	EFFECTIVE LUMENS 456 lm (ea)	METRIC 86mm x 48mm x 23mm
WATTAGE / AMPS 6W / 0.5A	VIBRATION RATING 8.6 Grms	WEIGHT 0.41 lb / 0.19 kg



ITEM #	PART #	COLOR	ITEM #	PART #	COLOR
XIL-UF32	4001824	White	XIL-UF32G	9121277	Green
XIL-UF32A	9119298	Amber	XIL-UF32R	9121369	Red
XIL-UF32B	9121185	Blue	XIL-UF32P	9135045	Purple

AVAILABLE COLORS



HEAVY DUTY LED BEACON



ITEM #: MIL-HDBA Shown
PART #: 9895123

180 LED HEAVY DUTY STROBING SAFETY BEACON

360° Visibility | Rugged Die-Cast Aluminum Housing | Shatterproof Polycarbonate Lens

LEDS 180	WARRANTY Extended	DIMENSIONS 5.31" x 5.12" x 5.31"
AREA OF EFFECT Full 360° Visibility	FLASH TYPE Dual	METRIC 135mm x 130mm x 135mm
WATTAGE / AMPS 36W / 3.0A	VIBRATION RATING 15.6 Grms	WEIGHT 2.96 lb / 1.34 kg



ITEM #	PART #	COLOR	ITEM #	PART #	COLOR
MIL-HDBA	9895123	Amber	MIL-HDBR	9893174	Red
MIL-HDBB	9893167	Blue	MIL-HDBW	9895130	White
MIL-HDBG	9895314	Green			



ITEM #: XIL-LP625.B.2HZ Shown
PART #: 9887838

DRIFT STROBE LED LIGHT

APPLICABLE MODEL ALL UNDERGROUND EQUIPMENT

RAW LUMENS 684 lm	WARRANTY Extended	DIMENSIONS 8.43" x 2.06" x 2.45"
LEDS 3 LED	VOLTAGE 12V DC	METRIC 214mm x 52mm x 62mm
WATTAGE / AMPS 9W / 0.6A	VIBRATION RATING 15.6 Grms	WEIGHT 2.00 lb / 0.91 kg



ITEM #	PART #	COLOR
XIL-LP625.B.2HZ	9887838	Blue
XIL-LP625.A.2HZ	9888002	Amber
XIL-LP625.G.2HZ	9887845	Green
XIL-LP625.R.2HZ	9888019	Red

2D VIEW

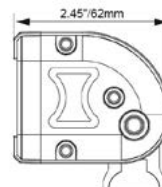
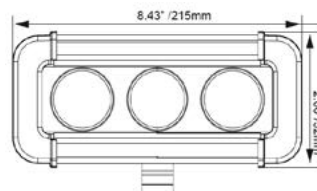

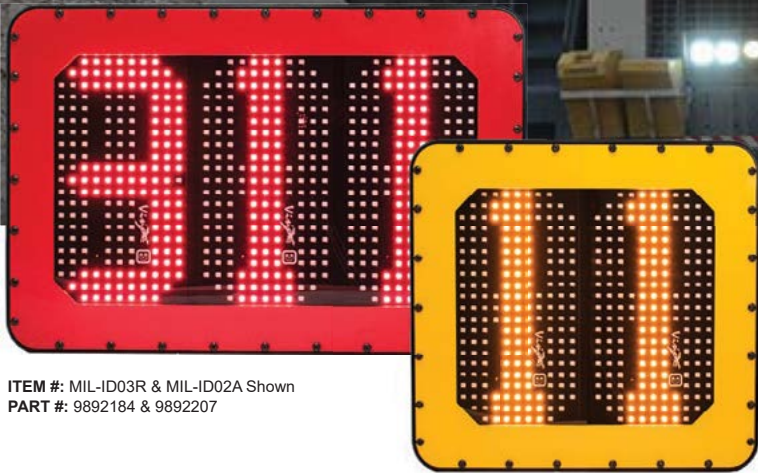

ITEM #: MIL-ID03R & MIL-ID02A Shown
PART #: 9892184 & 9892207

2 & 3 DIGIT LED VEHICLE ID BOARD

AUTO DIM/BRIGHT FOR DAY AND NIGHTTIME OPERATION

195 Crisp LEDs Per Digit | Magnetic Sensor To Change Digits | Engineered For 24/7 Operation

WEIGHT 19.80 lb / 8.98 kg 14.85 lb / 6.73 kg	VOLTAGE 12V DC	DIMENSIONS 29.84" x 17.26" (3 Digit) 22.56" x 17.32" (2 Digit)
VIBRATION RATING 15.6 Grms	WATTAGE / AMPS 117W / 9.75A @ 12V DC (3 Digit) 78W / 14.85A @ 12V DC (2 Digit)	METRIC 758mm x 439mm (3 Digit) 573mm x 440mm (2 Digit)

ITEM #	PART #	DIGITS	COLOR
MIL-ID03A	9892719	3	Amber
MIL-ID03R	9892184	3	Red

ITEM #	PART #	DIGITS	COLOR
MIL-ID02A	9892207	2	Amber
MIL-ID02R	9892191	2	Red

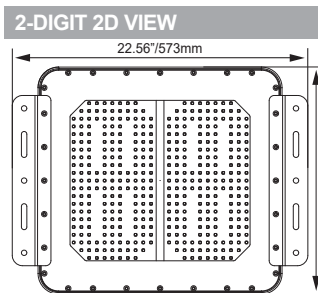
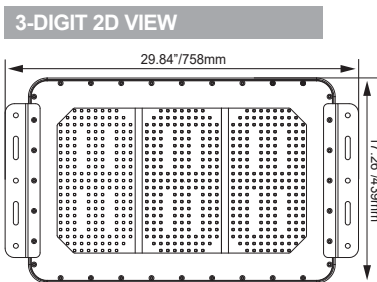

MARITIME

ABOUT THE MARITIME SERIES

The Vision X Marine line provides the ideal solution for watercraft of all sizes. From commercial freight ships to fishing vessels, we carry lighting designed specifically for the maritime market. Each electronics board used in the Maritime line is constructed from copper and are above ground to remove corrosion issues typically common in saltwater applications.

Additionally, the marine grade gloss coating reduces wear from constant barrage of saltwater while at sea, ensuring the light performs day in and day out. The heavy duty stainless steel bracket combines maximum strength with a bracket that won't deteriorate over time.

Maritime products operate at a 5000K color temperature, giving the light a warmer feel.

ABOVE GROUND MARITIME

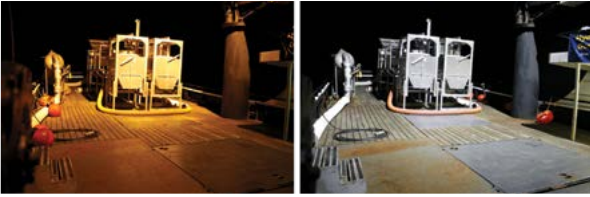

SALTWATER PROTECTION

The unique gloss coating used on Maritime products from Vision X greatly reduces the dramatic impact that saltwater has on traditional lighting fixture housings.

STAINLESS STEEL BRACKET



INCLUDED MOUNTING

The each fixture in the MAR Series from Vision X comes equipped with a high-strength stainless steel bracket that gives the light extra protection against saltwater corrosion.

COPPER BOARD



ANTI-CORROSION

The Maritime products from Vision X feature an above ground copper electronic board to eliminate any chance of corrosion.



MARITIME RIPPER 20



ITEM #: MAR-RXP2060 Shown
PART #: 9892108

STAINLESS STEEL BRACKET WITH UPGRADED ELECTRONICS FOR MARINE USE
60 Grms High Vibration Rating | Single Bolt Mounting | Stainless Steel Trunnion Bracket

BEAM PATTERNS 10°, 25°, 40°, 60°, 90°, 30°x65°	WARRANTY Extended	DIMENSIONS 8.26" x 6.24" x 4.05"
RAW LUMENS 10,560 lm (ea)	EFFECTIVE LUMENS 7,400 lm (ea)	METRIC 210mm x 159mm x 103mm
WATTAGE / AMPS 100W / 8.34A @12V	VIBRATION RATING 60 Grms	WEIGHT 8.4 lb / 38 kg



ITEM #	PART #	QTY	BEAM
MAR-RXP2040	9893020	1	40°
MAR-RXP2060	9892108	1	60°

BEAM PATTERN

MAR-RXP2060 | 9892108 - 60° Beam

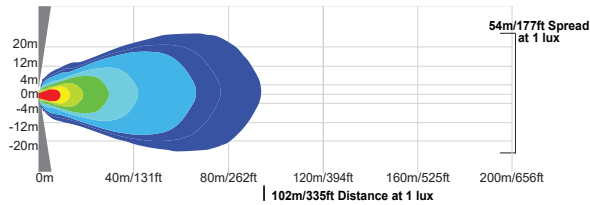

2D VIEW

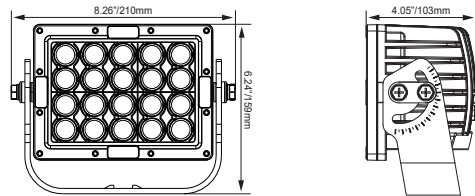

MARITIME RIPPER 12



ITEM #: MAR-RXP1260 Shown
PART #: 9892092

STAINLESS STEEL BRACKET WITH UPGRADED ELECTRONICS FOR MARINE USE
60 Grms High Vibration Rating | Single Bolt Mounting | Stainless Steel Trunnion Bracket

BEAM PATTERNS 10°, 25°, 40°, 60°, 90°, 30°x65°	WARRANTY Extended	DIMENSIONS 6.06" x 6.28" x 4.05"
RAW LUMENS 6,336 lm (ea)	EFFECTIVE LUMENS 4,440 lm (ea)	METRIC 154mm x 160mm x 103mm
WATTAGE / AMPS 60W / 5.0A @12V	VIBRATION RATING 60 Grms	WEIGHT 5.51 lb / 2.5 kg



ITEM #	PART #	QTY	BEAM
MAR-RXP1240	9893037	1	40°
MAR-RXP1260	9892092	1	60°

BEAM PATTERN

MAR-RXP1260 | 9892092 - 60° Beam

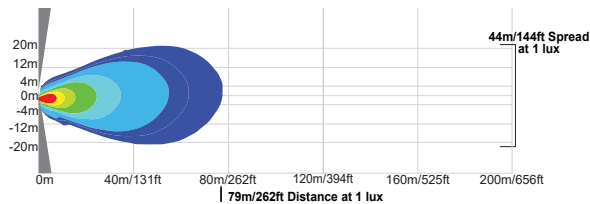

2D VIEW

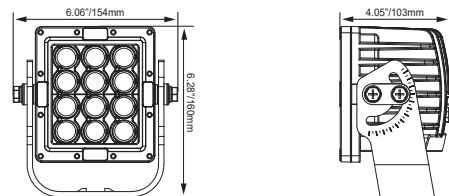

MARINE EXPLORER 7



ITEM #: MIL-EPX760 Shown
PART #: 9892115

STAINLESS STEEL BRACKET WITH UPGRADED ELECTRONICS FOR MARINE USE
Stainless Steel Trunnion Bracket | Single Bolt Mounting | CISPR 25 Rated For Marine Use

BEAM PATTERNS 10°, 25°, 40°, 60°, 90°, 30°x65°	WARRANTY Extended	DIMENSIONS 6.43" x 5.50" x 3.12"
RAW LUMENS 3,696 lm (ea)	EFFECTIVE LUMENS 2,590 lm (ea)	METRIC 163mm x 140mm x 79mm
WATTAGE / AMPS 35W / 2.9A @12V	VIBRATION RATING 15.6 Grms	WEIGHT 4.0 lb / 1.81 kg



ITEM #	PART #	QTY	BEAM
MAR-EPX740	9893044	1	40°
MAR-EPX760	9892115	1	60°

BEAM PATTERN

MAR-EPX760 | 9892115 - 60° Beam

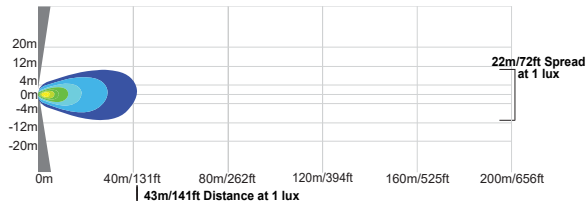

2D VIEW

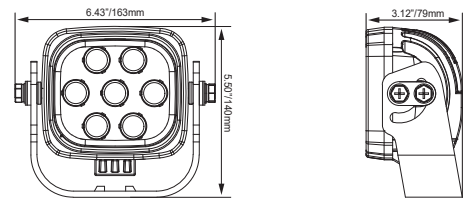

MARINE 4.5" LIGHT CANNON



ITEM #: CTL-CPZ110WKIT Shown
PART #: 9151069

WHITE MARINE GRADE 4.5" LIGHT CANNON
Available snap-on Polycarbonate Covers | 1,000 feet of usable light

BEAM PATTERNS 10°	WEIGHT 2.02 lb / 0.92 kg	DIMENSIONS 4.72" x 5.75" x 4.35"
RAW LUMENS 2,500 lm (ea)	DISTANCE TO 1 LUX 1,000'	METRIC 120mm x 147mm x 110mm



ITEM #	PART #	QTY	BEAM
CTL-CPZ110WKIT	9151069	2	10°

BEAM PATTERN

CTL-CPZ110WKIT | 9151069 - 10° Beam

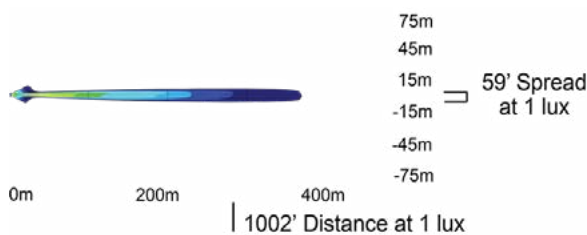

2D VIEW

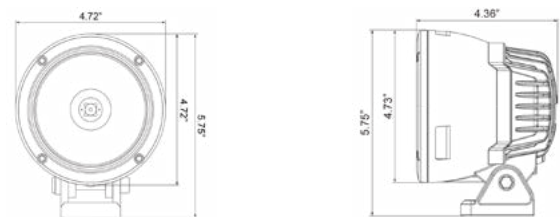

REDUCING
RISK, WHILE
IMPROVING

**SAFETY AND
PRODUCTIVITY**



CONTACT US

APS USA (Head Office)

610 Gateway Center Way, Suites J & K,
San Diego, CA 92102 USA
P: 1 619 263 4164
F: 1 619 263 6814
sales@aps-supply.com

APS AUSTRALIA (Perth)

Inspiration Business Park
Unit 48 / 9 Vision Street,
Wangara, WA 6065 Australia
P: 61 (8) 9302 2369
F: 61 (8) 6305 0047
sales.apsa@aps-supply.com

APS AUSTRALIA (Beresfield)

Unit 11 / 21 Babilla Close,
Beresfield, NSW 2322 Australia
P: 61 (2) 4915 6781
sales.apsa@aps-supply.com

APS CHILE

Avda. Américo Vespucio 1385,
Edificio B, Modulo 17 ,Quilicura
T: 56 (2) 2948 8044
T: 56 (2) 2948 8045
sales.apschile@aps-supply.com

APS COLOMBIA

Calle 69S #34-314
Edlf. Palo Santo, ofic.403
Medellin, Colombia
T: 57 (4) 444 7275
C: 57 320 699 4595
sales.apscolombia@aps-supply.com

APS PERU

San Martin N. 472
Lima 18, Perú
T: 51 (1) 242 2719
F: 51 (1) 241 3135
sales.apsperu@aps-supply.com